

## Technical Manual

SATION PUSH BUTTON



SATION-PM1308.110X  
SATION-PM1308.112X  
SATION-PM1308.210X  
SATION-PM1308.212X

## 1 Catalogue

### Content

<b>1 Catalogue</b> .....	<b>2</b>
<b>2 Overview</b> .....	<b>3</b>
<b>2.1 Device Overview</b> .....	<b>3</b>
<b>2.2 Sketch Map</b> .....	<b>3</b>
<b>2.3 Use And Usage</b> .....	<b>4</b>
<b>2.4 Structure Description</b> .....	<b>4</b>
<b>2.5 Functions</b> .....	<b>4</b>
2.5.1 Functions Overview.....	5
<b>3 Communication Object</b> .....	<b>6</b>
<b>3.1 Object corresponding to channel</b> .....	<b>6</b>
<b>3.2 Logical object</b> .....	<b>8</b>
<b>3.3 LED Object</b> .....	<b>9</b>
<b>4 ETSPParameter</b> .....	<b>10</b>
<b>4.1 General settings</b> .....	<b>10</b>
<b>4.2 Configuration</b> .....	<b>11</b>
<b>4.3 Same parameter configuration</b> .....	<b>11</b>
4.3.1 Blocking object.....	11
<b>4.4 Group mode parameter configuration</b> .....	<b>12</b>
4.4.1 Dimming.....	13
4.4.2 Shutter Control.....	15
4.4.3 Switching.....	16
<b>4.5 Independent mode parameter configuration</b> .....	<b>17</b>
4.5.1 switch.....	17
4.5.2 (Scene).....	26
4.5.3 Switch short/long.....	28
4.5.4 One button Dimming.....	31
4.5.5 One button Shutter.....	33
<b>4.6 Logic</b> .....	<b>34</b>
4.6.1 Logic object type switch.....	36
4.6.2 Logic object type scene.....	38
4.6.3 Logic object type byte value.....	38
<b>4.7 LED instructions</b> .....	<b>39</b>
4.7.1 LED Configuration.....	40

## 2 Overview

### 2.1 Device Overview

This manual is applicable to the following equipment:

- SATION-PM1308.110X
- SATION-PM1308.112X
- SATION-PM1308.210X
- SATION-PM1308.212X

## 2.2 Sketch Map

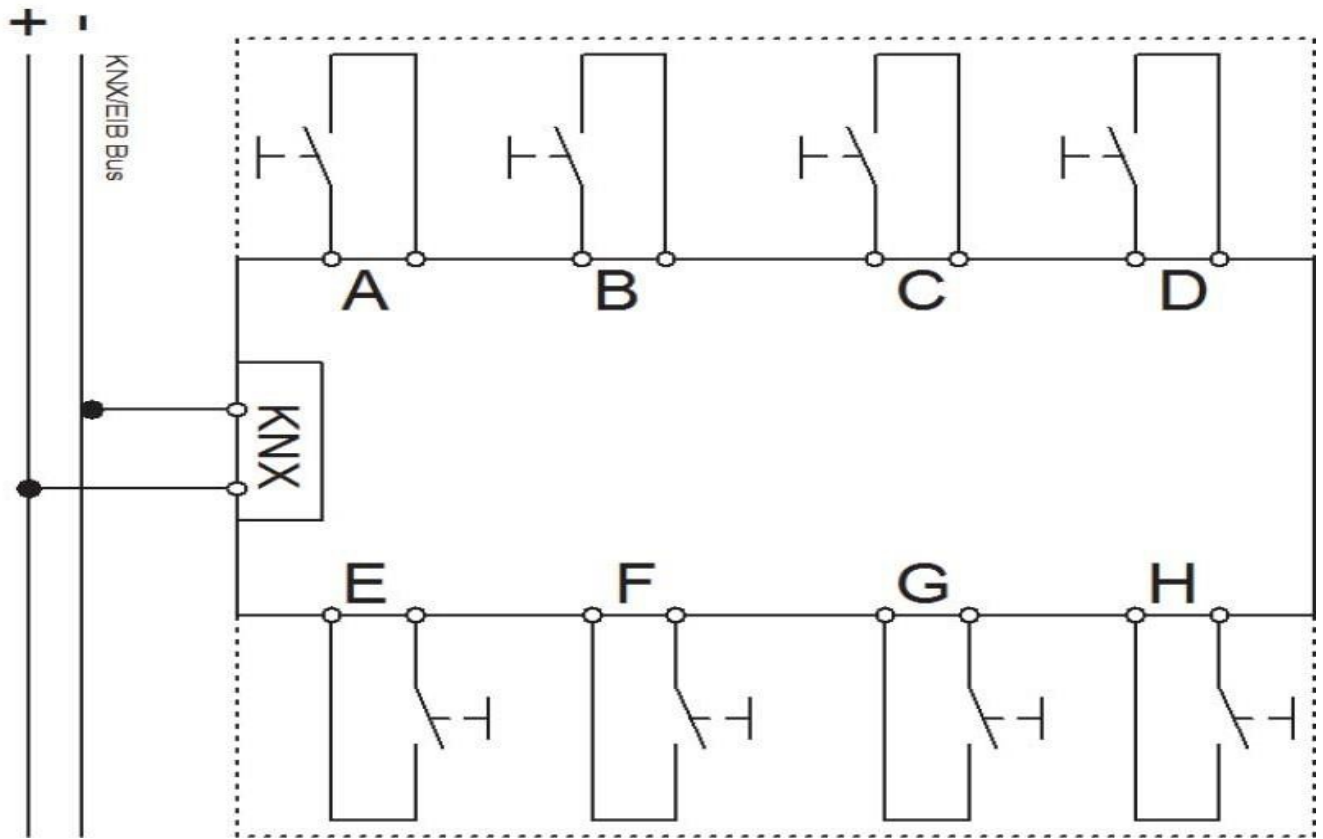

Picture1: Wiring diagram,8-Channel push button

## 2.3 Use And Usage

This equipment is used to replace the ordinary wall mounted mechanical switch and intelligitize the switch signal. At present, it has 2, 4, 6, 8 keys and other styles. Each key is equipped with two colors of LED lights, which can be flexibly configured for its purpose.

## 2.4 Structure Description

Each product is composed of BCU and panel. BCU is installed in the wall, and mechanical panel is inserted on BCU. Only BCU is needed for product programming and configuration, and panel is not needed.



picture 2:structure description

## 2.5 Functions

The following functions are applicable to all channels. In addition, the device supports 4 logic functions, each channel is equipped with LED status indication which can be flexibly configured. The functions of each channel are as follows:

- **Disabled** This option indicates that the current channel is disabled without any response.
- **Channels grouped** This option indicates that two adjacent channels are used together.
- **Channels unique** This option indicates that two adjacent channels are used independently.

## 2.5.1 Functions Overview

General settings	Time for keystroke long	0.1-30s, optional
	Startup time	Start delay time (0-60s)
	Behaviour at Bus power up	Power on start behavior configuration
	Button Style	Select panel shape
Channels grouped	Dimming function	Lights on / off
	Shutter function	Shutter up / down, or left / right
	Switching function	On / off
Channels unique	Switching function	<ul style="list-style-type: none"> <li>• Switch function</li> <li>• Turnover function</li> <li>• Status function</li> <li>• Delay function</li> <li>• Edge delay sending function</li> <li>• forced setting function</li> <li>• Sending value function</li> </ul>
	Scene function	<ul style="list-style-type: none"> <li>• Storage function</li> <li>• scene selection</li> </ul>
	Switch short/long	<ul style="list-style-type: none"> <li>• on / off / turnover</li> <li>• short press / long press independent configuration</li> </ul>
	One button dimming	<ul style="list-style-type: none"> <li>• One key dimming</li> </ul>
	One button shutter	<ul style="list-style-type: none"> <li>• One button curtain control</li> </ul>
Logic functions	AND function	<ul style="list-style-type: none"> <li>• Switch function</li> <li>• Scene function</li> <li>• reverse function</li> </ul>
	OR function	<ul style="list-style-type: none"> <li>• Switch function</li> <li>• Scene function</li> <li>• reverse function</li> </ul>
Configuration of LEDs	Status-LEDs	<ul style="list-style-type: none"> <li>• through internal object control</li> <li>• control through external objects</li> <li>• respond to key actions</li> <li>• LED display behavior</li> <li>• LED lighting mode</li> </ul>
	Operating LED	<ul style="list-style-type: none"> <li>• On / off</li> <li>• control through external objects</li> </ul>

Form 1:function overview

## 3 Communication Object

### 3.1 Object corresponding to channel

Each channel has five corresponding object numbers, 0-4, 5-9 and so on. The object location will be permanently occupied and will not change with the mode change. This means that if channel A and channel B are configured as grouped mode, they will use the object with number 0-4 together. The object with number 5-9 will no longer be used, but its corresponding position in memory will still be occupied. The number of channel C and channel D will still be from 10-14, 15-19, and so on. In addition, 12 logical objects follow the channel object. For 8 channels, the object number is 40-51, for 4 channels, the object number is 20-31, and so on.

LED objects start from the back of logical objects. For 8 channels, there are 8 LED objects, numbered 52-59. For 4 channels, there are 4 LED objects, numbered 32-35.

The following figure is a channel configuration diagram. Channel 1 / 2 is configured as combination mode and dimming function. Channel 3 / 4 is configured as independent mode, 3 as switch function and 4 as scene function. Channel 5 / 6 is configured as independent mode, 5 as curtain control function and 6 as switch function. Channel 7 / 8 is configured as combination mode and curtain control function :

Number	Name	Object Function	Description	Group Addresses	Leng...
0	Buttons 1 / 2	Dimming on/off			1 bit
1	Buttons 1 / 2	Dimming			4 bit
10	Button 3	Switch			1 bit
11	Button 3	Value for toggle			1 bit
17	Button 4	Scene			1 Byte
20	Button 5	Shutter			1 bit
21	Button 5	Blinds/Stop			1 bit
25	Button 6	Switch			1 bit
30	Buttons 7 / 8	Shutter Down/Up			1 bit
31	Buttons 7 / 8	Stop/Blinds Open/Cl...			1 bit

picture: Channel object configuration

If a group of channels is disabled, the corresponding channel object will not be displayed, and the corresponding parameters are also not configurable.

The following table shows the related objects corresponding to a channel. The same number indicates that the object functions are different in different configurations:

NO.	Functions	Usage	Data point Type	Read/Write
0	Switch	Edge delay control	DPT 1.001	read
0	Send forced setting	Send forced setting	DPT 2.001	read
0	Shutters down/up	Shutter control	DPT 1.008	read
0	Dimming on/off	Turnover dimming	DPT 1.001	read
0	Switch on/off	Double key control switch	DPT 1.001	read
0	Send value	Send settings	DPT 5.001	read
0	Push button short	Send short press behavior	DPT 1.001	read
1	Value for toggle	Edge extension control flip value	DPT 1.001	write
1	Stop/Blinds open/close	Curtain drive / shutter stop	DPT 1.009	read
1	Dimming	Dimming	DPT 3.007	read
2	Scene	Scene	DPT 18.001	read
2	Value for change of direction	Direction of curtain movement	DPT 1.001	read
2	Push button long	Send long press behavior	DPT 1.001	read
<b>+5</b>	<b>Next channel</b>			



Form 2: single channel object



## 3.2 Logical object

Each device has 4 logic functions. Each logic function is equipped with two logic input objects and one logic output object, and any channel can be selected to participate in logic operation. For 6-channel devices, the object number starts from 30 and ends at 41, and for 8-channel devices, the number starts from 40 and ends at 51.

The following table shows 6-channel devices, logical object 1:

	Number ▲	Name	Object Function
	30	Logic	Input 1 A
	31	Logic	Input 1 B
	32	Logic	Output 1

Picture 3:logical object

If the logical function is not used, the corresponding object will not be displayed. Each device contains four logical object function blocks.

The following table shows the objects corresponding to a logical function:

NO.	Functions	Usage	Data point Type	Read/Write
30/40	Logic input 1A	Logic input A	DPT 1.001	write
31/41	Logic input 1B	Logic input B	DPT 1.001	write
32/42	Logic output 1	Logic output	DPT 1.001	write
32/42	Logic output 1 scene	Logic output scenario	DPT 18.001	write
<b>+3</b>	<b>Next logic block</b>			

Form :3 logical object description

Two logic input objects (A / b) of each logic block can receive external signals for logic operation. In addition, each channel of the device can be used as logic input, and can participate in logic operation after configuration selection.

## 3.3 LED Object

Each channel is equipped with a two-color LED lamp, each lamp is equipped with an object to receive external signals, so the LED display mode can be flexibly configured. For example, respond to the device key action, or indicate the external switch status. For 8-channel devices, there are 8 LED objects in total, and for 4-channel devices, there are 4 LED objects in total.

The figure below shows an LED:

52	LED 1	Switch LED 1	1 bit	C	-	W	T	U	switch	Low
53	LED 2	Switch LED 2	1 bit	C	-	W	T	U		Low
54	LED 3	Switch LED 3	1 bit	C	-	W	T	U	switch	Low
55	LED 4	Switch LED 4	1 bit	C	-	W	T	U	switch	Low
57	LED 6	Switch LED 6	1 bit	C	-	W	T	U	switch	Low
58	LED 7	Switch LED 7	1 bit	C	-	W	T	U	switch	Low
59	LED 8	Switch LED 8	1 bit	C	-	W	T	U	switch	Low

Picture8 : LED object

The following form describes LED object types:

NO.	Name	Usage	Data Type
52	LED1	Switch indication	DPT 1.001
53	LED2	Switch indication	DPT 1.001
54	LED3	Switch indication	DPT 1.001
55	LED4	Switch indication	DPT 1.001
56	LED5	Switch indication	DPT 1.001
57	LED6	Switch indication	DPT 1.001
58	LED7	Switch indication	DPT 1.001
59	LED8	Switch indication	DPT 1.001

Form : LED object

## 4 ETS Parameter

### 4.1 General settings

The following parameters affect all channels:

picture 3: general settings

The following form is the parameter description:

Parameter Name	Range [Default]	Remarks
Time for keystroke long	0.1-30s [0.8s]	Long key determination time (when it is greater than this value, it is a long key). When it is necessary to distinguish between long and short keys, it is necessary to determine this value
Startup time	0-60s [1s]	Wait time before starting the application after the device is powered on
Behavior at bus power up	<ul style="list-style-type: none"> <li>• <b>No read value for toggle</b></li> <li>• Read value for toggle</li> </ul>	Whether to read the turnover value when the device is reset. The default value is 0
Button Style	<ul style="list-style-type: none"> <li>• <b>4 square rockers</b></li> <li>• 4 rectangular rockers</li> <li>• 2 square,2 rectangular rockers</li> <li>• 2 rectangular,2 square rockers</li> <li>• 2 square rockers in the middle</li> </ul>	The selection of panel shape, which affects the corresponding relationship of key number position, must correspond to the panel shape of actual equipment For example: If the actual panel shape is 4-way square, select 4 square rockers If the actual panel shape is 4-joint rectangle, select 4 rectangular rockers

Form 4: general settings

## 4.2 Configuration

The following figure shows the channel function selection:

The screenshot shows a configuration interface with four rows of function button settings. Each row consists of a text label on the left and a dropdown menu on the right. The labels are: 'Function buttons 1 / 2 (at the top, left / right)', 'Function buttons 3 / 4 ( 2. line, left / right)', 'Function buttons 5 / 6 (3. line, left / right)', and 'Function buttons 7 / 8 (at the bottom, left / right)'. The dropdown menus contain the following values: 'Push buttons grouped', 'Push buttons unique', 'disabled', and 'disabled' respectively.

Picture 4: channel mode

Function Description:

Parameter Name	Range [Default]	Remarks
Function Button 1/2	<ul style="list-style-type: none"> <li>• Disabled</li> <li>• Channels grouped</li> <li>• Channels unique</li> </ul>	Channel working mode: Disabled indicates that the channel is not working, grouped indicates that two adjacent channels are combined, and unique indicates that the channel works independently.

Form 5:channel parameter

## 4.3 Same parameter configuration

### 4.3.1 Blocking object

No matter in combination mode or independent mode, the channel can activate the blocking function. The difference is that in combination mode, two adjacent channels share a blocking object. In independent mode, the channel has its own blocking object.

The following is the object description:

NO.	Name	Length	Usage
4	Blocking object	1bit	When a value of 1 is received, the channel is blocked (the channel will no longer generate any action), and the value of 0 returns to normal

Form 6: blocking object

## 4.4 Group mode parameter configuration

The following form shows the group mode parameter options:

Parameter Name	Range [Default]	Remarks
Button A/B	<ul style="list-style-type: none"> <li>• <b>Dimming</b></li> <li>• Shutter</li> <li>• Switch</li> </ul>	Working mode selection: dimming, shutter, switch
Dimming function A/B	<ul style="list-style-type: none"> <li>• <b>Brighter/Darker</b></li> <li>• Darker/Brighter</li> </ul>	Set dimming mode, the former is A, the latter is B
Shutter function A/B	<ul style="list-style-type: none"> <li>• <b>Up/Down</b></li> <li>• Down/Up</li> </ul>	Set curtain control, the former is A, the latter is B
Switch function A/B	<ul style="list-style-type: none"> <li>• <b>On/Off</b></li> <li>• Off/On</li> </ul>	Set the switch mode, the former is A, the latter is B
Blocking Object	<ul style="list-style-type: none"> <li>• <b>Inactive</b></li> <li>• Active</li> </ul>	Set blocking function, disabled by default

Form 7: group mode parameter

When the combination mode is selected, the adjacent two channels will be configured as the combination function. As for which two channels are adjacent channels, it is related to the parameter button style. It is necessary to determine which two channels are a group according to the setting of this parameter. This parameter also affects the channels working in the independent mode.

The following two figures show the corresponding key (channel) position relationship of parameter type 4 rectangular and 4 square rockers:

4 rectangular rockers

A	B
C	D
E	F
G	H

4 square rockers

A	C
B	D
E	G
F	H

## 4.4.1 Dimming

Two key dimming function works in combination mode

The following figure shows the parameter options:

The image shows a configuration interface with three dropdown menus. The first menu is labeled 'Buttons 1 / 2' and has 'Dimming' selected. The second menu is labeled 'Dimming Function 1 / 2' and has 'Darker/Brighter' selected. The third menu is labeled 'Blocking Object' and has 'Inactive' selected.

picture 5: Combined mode parameters

Parameter Description :

NO.	Name	Length	Usage
0	Dimming on/off	1 bit	Switch function, short press effective
1	Dimming	4 bit	Dimming function, long press effective, relative dimming

Form 8: Composite mode dimming object

When a group of channels are configured as dimming function, two objects will appear. One 1-bit object corresponds to a short key, which is used to control on and off. One 4-bit object corresponds to a long key, which is used to control dimming. Because it is a 4-bit value, it is a relative dimming function.

Brighter / darker or darker / brighter can be configured at will. The former corresponds to the first input and the latter corresponds to the second input. For example, if channel A / B is configured as brighter / darker, then channel a is on and channel B is dark. When pressing the short key, channel a directly lights up and channel B directly turns off the light. When pressing the long key, channel a slowly lights up according to the set time, Channel B dims the light slowly. When the long key is used for dimming, release the key at any time in the middle, stop dimming, keep the current brightness of the light, and continue dimming from the current brightness when dimming again. When the brightness is adjusted to the maximum or minimum, the brightness will not change any more.

The following figure shows two channel dimming:

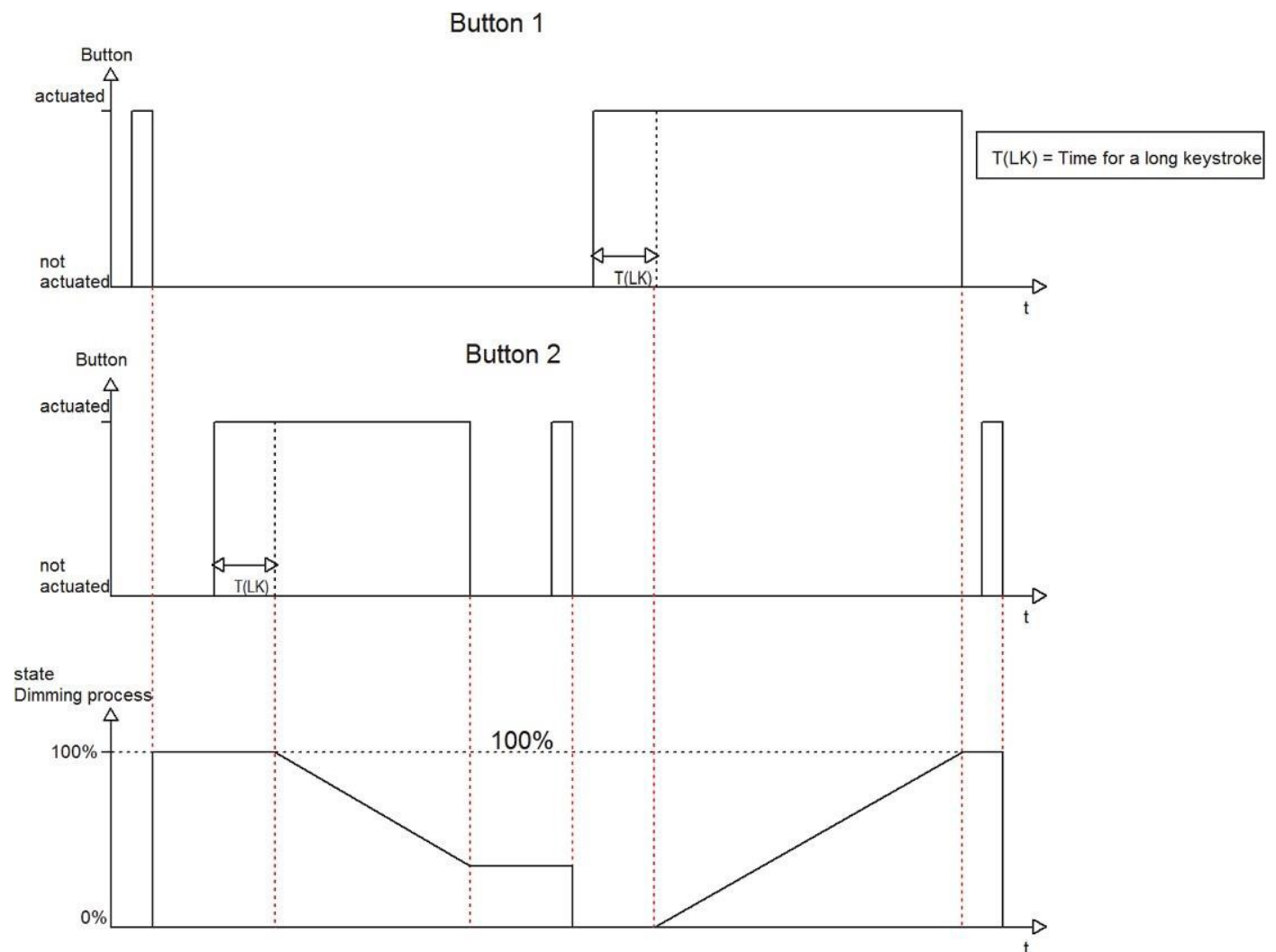

Picture 6: Double key dimming waveform

## 4.4.2 Shutter Control

Two key curtain control. It can control curtain and shutter.

The following figure is the parameter description:

The screenshot shows a configuration form with four rows of dropdown menus. The first row is labeled 'Buttons 1 / 2' and has a dropdown menu with 'Shutter' selected. The second row is labeled 'Shutter Function 1 / 2' and has a dropdown menu with 'Up, Down' selected. The third row is labeled 'Operation function' and has a dropdown menu with 'Long=move / short=stop/blinds' selected. The fourth row is labeled 'Blocking Object' and has a dropdown menu with 'Inactive' selected.

picture 7: two key shutter parameter

NO.	Name	Length	Usage
0	Shutter Down/Up	1 bit	Drive the curtain up and down, long button is effective
1	Stop/Blinds Open/Close	1 bit	Stop moving, the short key is valid

Form 9: two key shutter object

When channel A / B is configured as curtain control, and parameter selection is up / down, long press a key, the device will send a 0 signal, the curtain will move up, long press B key, the device will send a 1 signal, the curtain will move down. Short press a or B will send stop signal. If parameter selection is down / up, the A / b function will be interchanged. If operation mode selection is short = Move / long = stop / slats, Then the short key dims and the long key stops.



## 4.4.3 Switching

When two channels are configured as switch mode, switch control can be realized.

The image shows a configuration panel with three rows, each with a label on the left and a dropdown menu on the right:

- Buttons 1 / 2: Switch
- Switch function 1 / 2: off / on
- Blocking Object: Inactive

picture 8: two key switching parameter

Switching object description:

NO.	Name	Length	Usage
0	Switch On/Off	1 bit	Switch object

Form 10:two key swithing object

When channel A / B is configured as combination switch mode and the parameter on / off is selected, pressing a will send 1 signal, pressing B will send 0 signal, otherwise, sending 0 / 1 signal.

## 4.5 Independent mode parameter configuration

There are 7 functions to choose when the channel works in independent mode:

- Inactive
- Switch
- Scene
- Switch short/long
- One button dimming
- One button shutter

Where inactive is channel forbidden, and the corresponding parameters of the channel are no longer displayed.

### 4.5.1 switch

The switch function in independent mode can respond to different key actions (press, release) and delay sending function. When a certain sub option is selected, more other parameter options will appear. See the following section for parameter description.

The following figure shows the switch function options:

The screenshot shows a configuration window titled "Input C". It contains three main sections:

- Function:** A dropdown menu currently set to "Switch".
- Subfunction:** A dropdown menu currently set to "Toggle falling edge". The menu is open, showing the following options:
  - Switch rising edge
  - Toggle rising edge
  - Switch falling edge
  - Toggle falling edge (highlighted)
  - Send Status
  - Send value rising edge (1Byte / 2Bit)
  - Send value falling edge (1Byte / 2Bit)
  - Send value both edges (1Byte / 2Bit)
  - Send Status with on-delay
  - Send Status with off-delay
- Blocking Object:** A dropdown menu currently set to "Inactive".

Picture 9:switch parameter

## 4.5.1.1 Switch falling edge/rising edge/both edge

Side extension configuration parameter form:

Parameter name	Range [Default]	Remarks
Value for rising/falling edge	<ul style="list-style-type: none"> <li>On</li> <li>Off</li> </ul>	Open / close can be pressed / released at will

Form 11: Edge extension parameter configuration

When the channel selects switch rising edge or switch falling edge, an on or off signal will be sent under the corresponding action.

The following figure shows the effect of sending on signal when the channel is configured as switch rising edge:

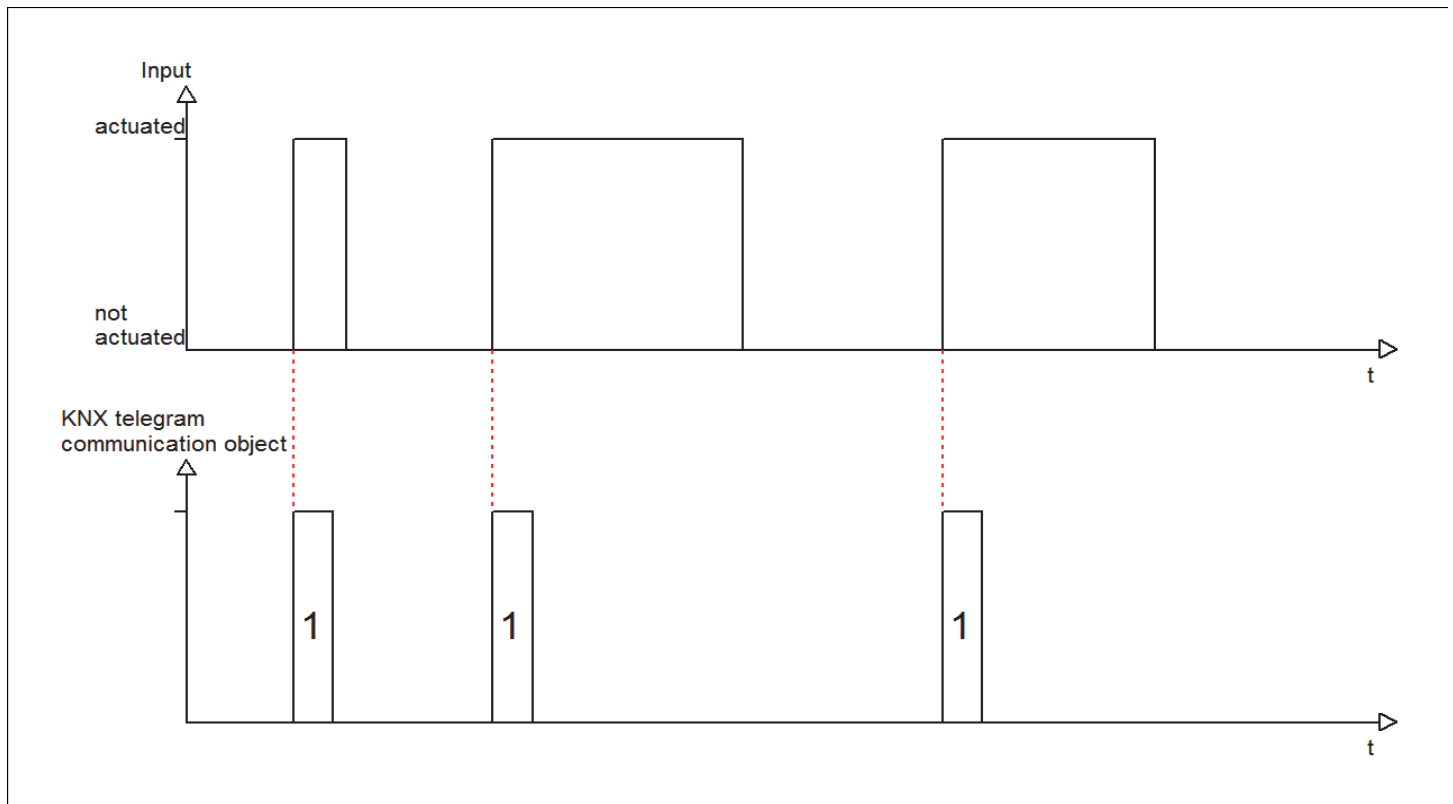

Picture 10: Press to send on signal

The following form is the corresponding communication object:

NO.	Name	Length	Usage
0	Switch	1 bit	Press the key to send the corresponding signal, long press / short press will not affect.

Form 12: Switch edge extension control

## 4.5.1.2 Toggle rising/falling edge

The channel can be configured to turnover up (press) or down (release) the output. Each turnover is based on the last state feedback, which means that the turnover object (value for toggle) must be associated with the target state object (state) to work properly.

The following figure shows the channel configured as descent delay (release), turnover function:

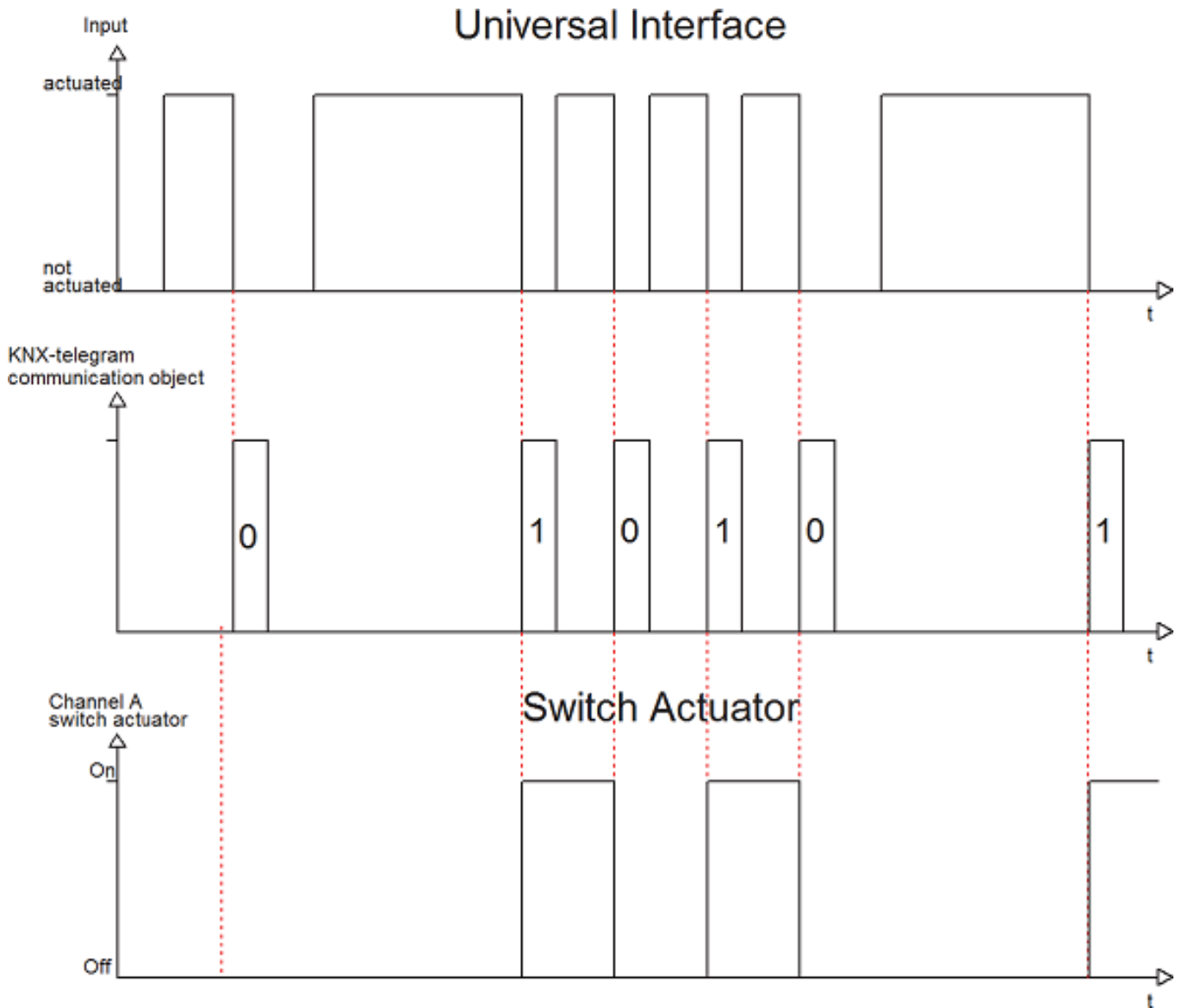

Picture 11: Descent rollover

The following form is the corresponding communication object:

NO.	Name	Length	Usage
0	Switch	1 bit	Press the key to send the corresponding signal, long press / short press will not affect.
1	Value for toggle	1 bit	Connect the state object to reflect the current state of the target, which is used for the turnover function.

Form 13: Edge rollover

The object value for toggle is related to the normal implementation of the turnover function. Therefore, it must be connected to the state object of the target channel. If there is no target object, it should be connected to the switch object of this channel. It can also be configured to read and update the object value when the device is powered on, so that it is consistent with the target state.

### 4.5.1.3 Send Status

When the channel is configured as switch and send status function, the channel can send the set value in up delay or down delay.

The following figure is the configuration diagram:

The configuration diagram shows the following settings:

- Function: Switch
- Subfunction: Send Status
- Value for push: On
- Value for release: Off
- Blocking Object: Inactive

picture 12: Send status value subfunction

Parameter Description:

Parameter Name	Range [Default]	Remarks
Value for rising edge	<ul style="list-style-type: none"> <li>On</li> <li>Off</li> </ul>	Send signal when pressed
Value for falling edge	<ul style="list-style-type: none"> <li>On</li> <li>Off</li> </ul>	Signal on release

form 14: Send status parameter

Parameter Description:

NO.	Name	Length	Usage
0	Switch	1 bit	Send switch value, no difference between long and short keys

Form 15: Send status object

The send status function can be used to complete some special functions and detect the closed status, such as the opening and closing status of the window. When the window is equipped with sensor contacts, the send status function can be used to send out the window status for monitoring. The current input status can also be sent regularly.

The figure below shows pressing to send 0 signal and releasing to send 1 signal:

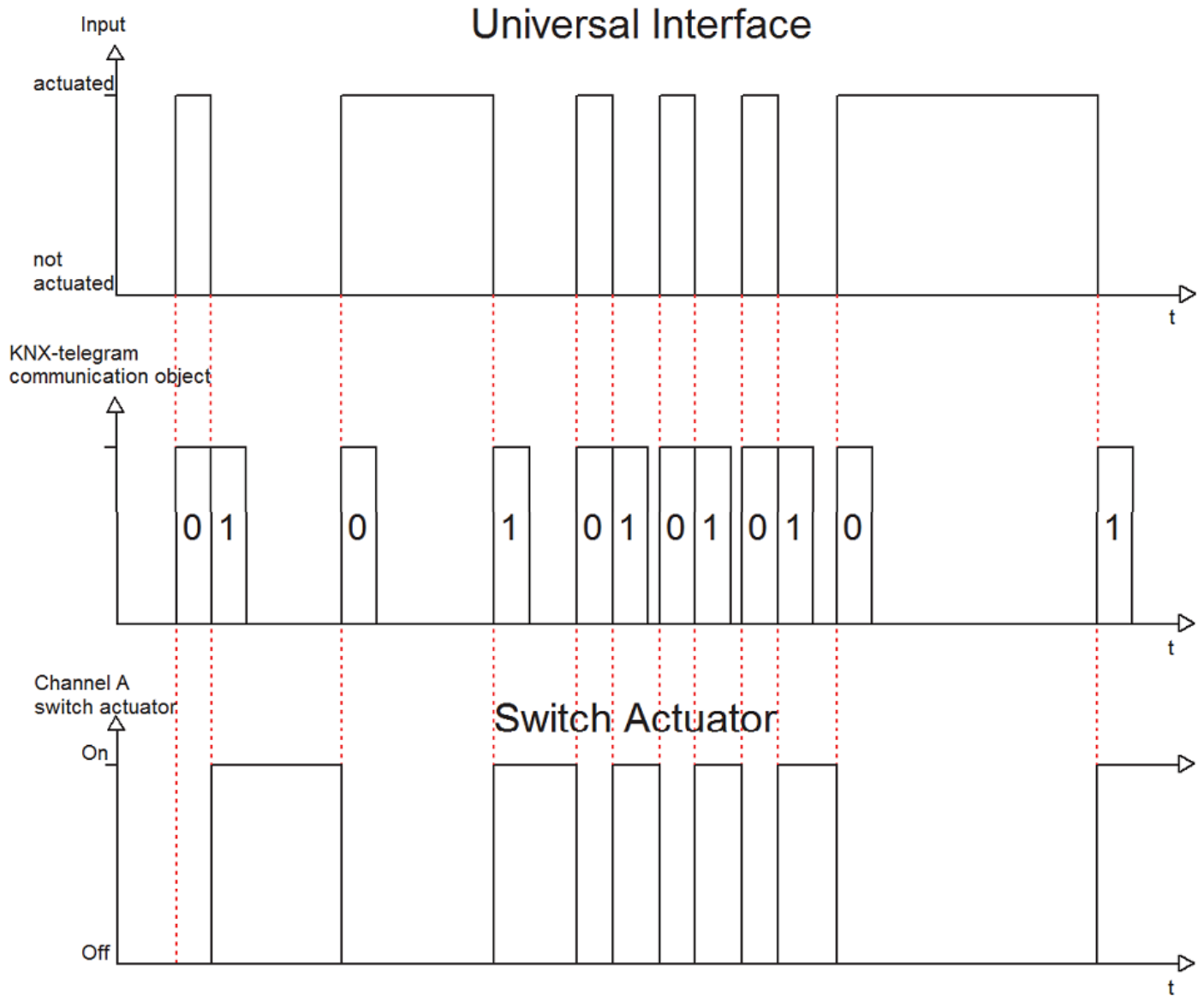

Picture 13: Send status value

## 4.5.1.4 Send Value rising/falling/both edges

There are two values to send, one is 1 byte and the other is 2 bits, depending on your choice.

Parameter display:

Function	Switch
Subfunction	Send value both edges (1Byte / 2Bit)
Value (1Byte) / forced setting (2Bit)	1 Byte value
Value for rising edge	0
Value for falling edge	0
Behaviour at Bus power up	send nothing
Blocking Object	Inactive

picture 14:function parameter

The following table shows the 1-byte value parameters:

Parameter Name	Range [Default]	Reamrks
Value for rising/falling edge	0-255 [0]	Send a 1 byte value at the set edge delay (up delay, down delay)

Form 16: 1 byte value

For a 1 - byte object, it can send any value in the range of 0 - 255, depending on your settings.

The following is the object description:

NO.	Name	Length	Usage
0	Send value	1 byte	Send settings

Form 16: 1 byte object

The following form shows the 2-bit value parameters:

Parameter Name	Range [Default]	Remarks
Send forced setting at rising/falling	<ul style="list-style-type: none"> <li>Forced setting not active</li> <li>Forced setting off</li> <li>Forced setting on</li> </ul>	Send a 2-bit value at the set edge delay (up delay, down delay)

Form 17: 1 byte value

This 2-bit object can be used for some functions, such as automatic control of human body induction. The parameters are as follows:

**Forced setting not active(control=0,value=0)**

The body sensor works normally.

**Forced setting off(control=1,value=0)**

The body sensor is forced to shut down, no longer sensing the external environment.

**Forced setting on(control=1,value=1)**

The body sensor is forced on.

2 bit value object:

NO.	Name	Length	Usage
0	Send forced setting	2 bit	Send setting value

Form 18: 2 bit value object

## 4.5.1.5 Send value with on/off delay

The following form describes the delay transmission parameters:

Parameter Name	Range [Default]	Remarks
Delay time	0-60min [1s]	Send value after delay setting time

Form 19: Delay transmission parameters



For the subfunction send value with on / off delay, that is, when sending on value or off value, delay for a certain time before sending. If the channel returns to the previous state before the delay is completed, the delay ends in advance and no value is sent. For example, if the channel is pressed, it will delay for 3 seconds to send on value. If the channel is released before the time arrives, the channel delay ends, The on value is no longer sent.

The following figure shows the operation:

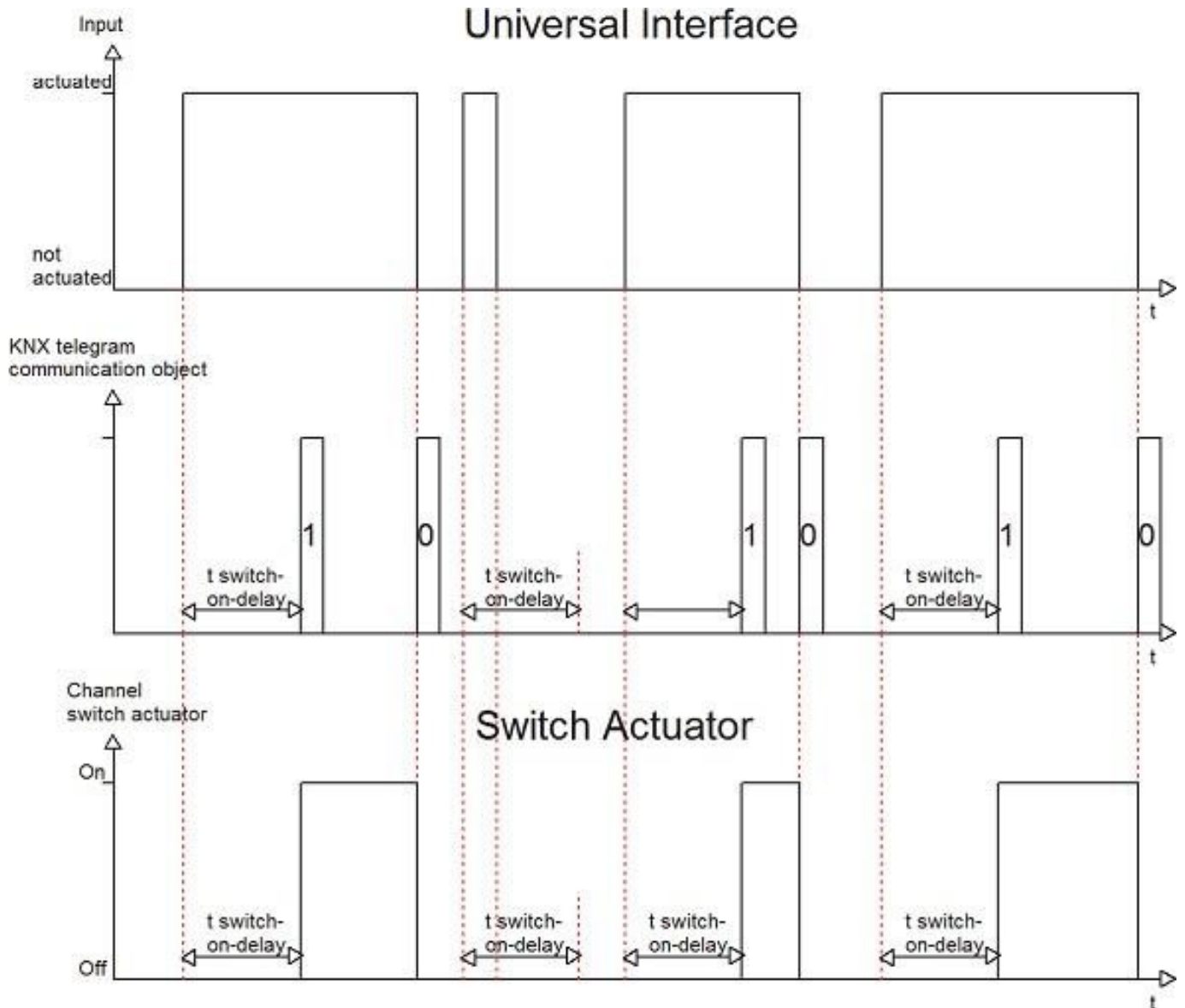

picture 15: Delayed transmission

Parameter picture:

Function	Switch
Subfunction	Send Status with off-delay
Delay time	1 s
Blocking Object	Active

Picture 16: Delay transmission parameter configuration

Object Description:

NO.	Name	Length	Usage
0	Switch	1 bit	Press the delay send on value to release the delay send off value

Form 20: delay send object

## 4.5.2 (Scene)

The scene function can be used to control multiple channels of one or more actuators to achieve a scene state. In addition, when the learning function is activated, the learning command can be sent by long keys.

The figure below shows the parameter configuration:

**Input D**

Function	<input type="text" value="Scene"/>
Subfunction	<input type="text" value="Save"/>
Scene Number	<input type="text" value="1"/>
Blocking Object	<input type="text" value="Inactive"/>

picture 17: scene parameter

The following form is the parameter description:

Parameter Name	Range [Default]	Remarks
Saving function	<ul style="list-style-type: none"> <li>• No save</li> <li>• <b>Save</b></li> </ul>	When the save function is activated, the long key can learn and save the current channel value.
Scene number	1-64 [1]	The scene number must be configured to be the same as the actuator
Blocking object	<ul style="list-style-type: none"> <li>• <b>Inactive</b></li> <li>• Active</li> </ul>	Block object, disabled by default

Form 21: scene parameter

Object Description:

NO.	Name	Lenrht	Usage
2	Scene	1 bit	Send scene value

Form 22: scene object

When the short key is pressed, the set scene number will be sent. The scene object with the same group address will receive the scene number and perform the corresponding action. When the learning function is activated, the long key will send a learning command to the associated actuator, and the actuator will save the current channel state to the corresponding scene number.

The following form shows the corresponding values of scenario sending and saving:

Scene	Send		Save	
	Hex.	Dez.	Hex.	Dez.
1	0x00	0	0x80	128
2	0x01	1	0x81	129
3	0x02	2	0x82	130
4	0x03	3	0x83	131
5	0x04	4	0x84	132
6	0x05	5	0x85	133
7	0x06	6	0x86	134
8	0x07	7	0x87	135
9	0x08	8	0x88	136
10	0x09	9	0x89	137
11	0x0A	10	0x8A	138
12	0x0B	11	0x8B	139
13	0x0C	12	0x8C	140
14	0x0D	13	0x8D	141
15	0x0E	14	0x8E	142
16	0x0F	15	0x8F	143
17	0x10	16	0x90	144
18	0x11	17	0x91	145
19	0x12	18	0x92	146
20	0x13	19	0x93	147
21	0x14	20	0x94	148
22	0x15	21	0x95	149
23	0x16	22	0x96	150
24	0x17	23	0x97	151
25	0x18	24	0x98	152
26	0x19	25	0x99	153
27	0x1A	26	0x9A	154
28	0x1B	27	0x9B	155
29	0x1C	28	0x9C	156
30	0x1D	29	0x9D	157
31	0x1E	30	0x9E	158
32	0x1F	31	0x9F	159

Form 23: Scene number and saved value

## 4.5.3 Switch short/long

Long press / short press can be independently assigned to on / off / turnover / send value and other functions.

The following figure shows the parameter options:

**Input C**

Function	<input type="text" value="Switch short/long"/>
Value for keystroke short - Object 1	<input type="text" value="On"/>
Value for keystroke long - Object 2	<input type="text" value="Toggle"/>
Blocking Object	<input type="text" value="Inactive"/>

Picture 20: Long press / short press parameters

The following table is the parameter description:

Parameter Name	Range [Default]	Remarks
Value for keystroke short object 1	<ul style="list-style-type: none"> <li>• On</li> <li>• Off</li> <li>• Toggle</li> <li>• Send value</li> <li>• Nothing</li> </ul>	Action on short key
Value for keystroke long object 2	<ul style="list-style-type: none"> <li>• On</li> <li>• Off</li> <li>• Toggle</li> <li>• Send value</li> <li>• <b>Nothing</b></li> </ul>	Action on long button
Blocking object	<ul style="list-style-type: none"> <li>• <b>Inactive</b></li> <li>• Active</li> </ul>	

Form 26: Long press / short press parameters

The following form describes the objects:

NO.	Name	Length	Usage
0	Push-button short	1 bit	Object for short keys
1	Value for toggle short	1 bit	Short key turnover value
2	Push-button long	1 bit	Object for long keys
3	Value for toggle long	1 bit	Long key turnover value

Form 27: Long press / short press object

Single key long short key function can be used to control two channels, which can save one key. Or it can also be short press on, long press off, short press turnover, long press turnover, etc. when configured as turnover function, the corresponding turnover object must be connected to the state object of the controlled actuator channel to realize correct turnover.

The following figure is the command description. Long press / short press are both set to turnover function. Long press control actuator channel A and short press control channel B:

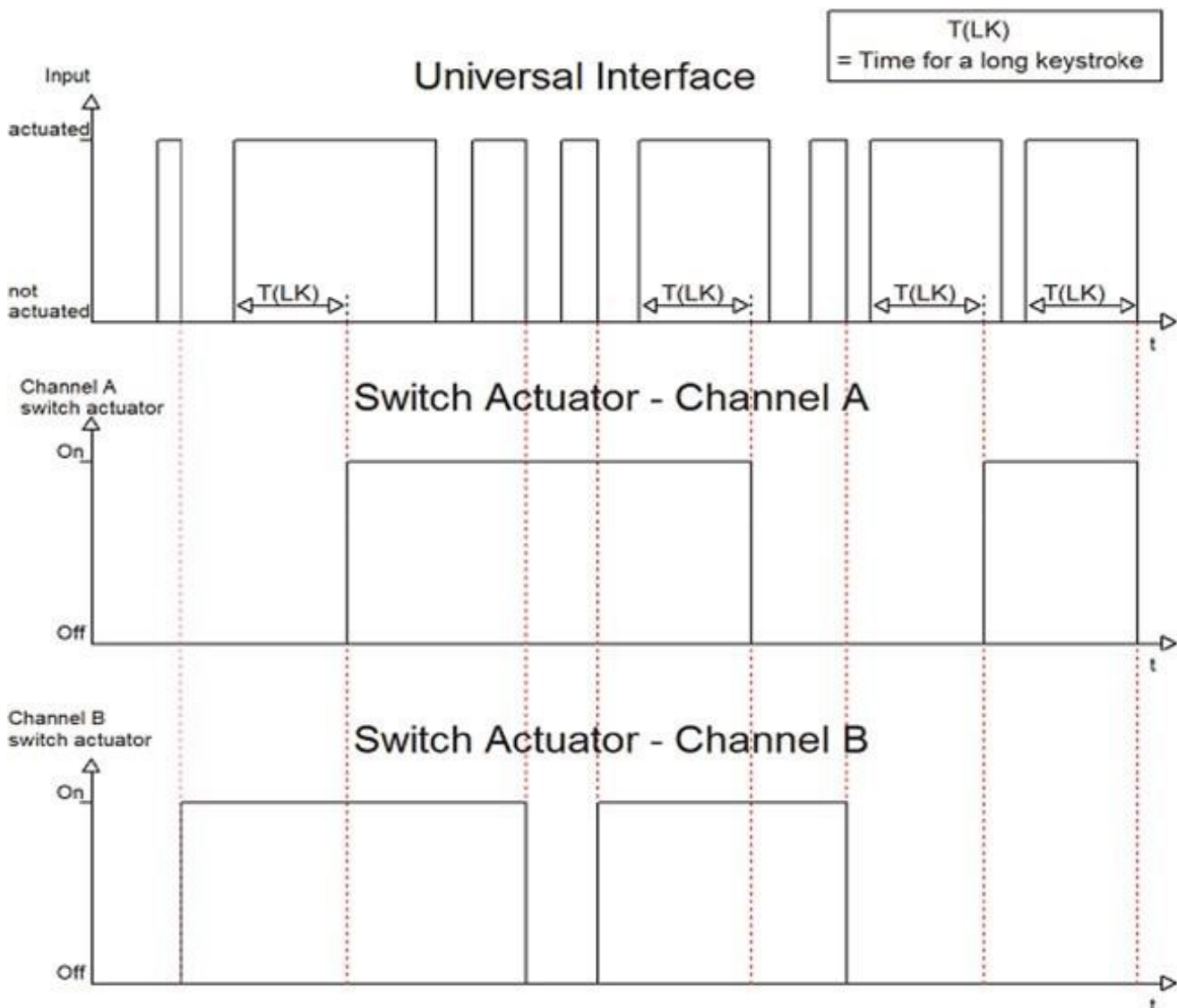

Picture 21: Long press / short press are independent

As shown in the following figure, long press / short press are used together. Long press to open and short press to close:

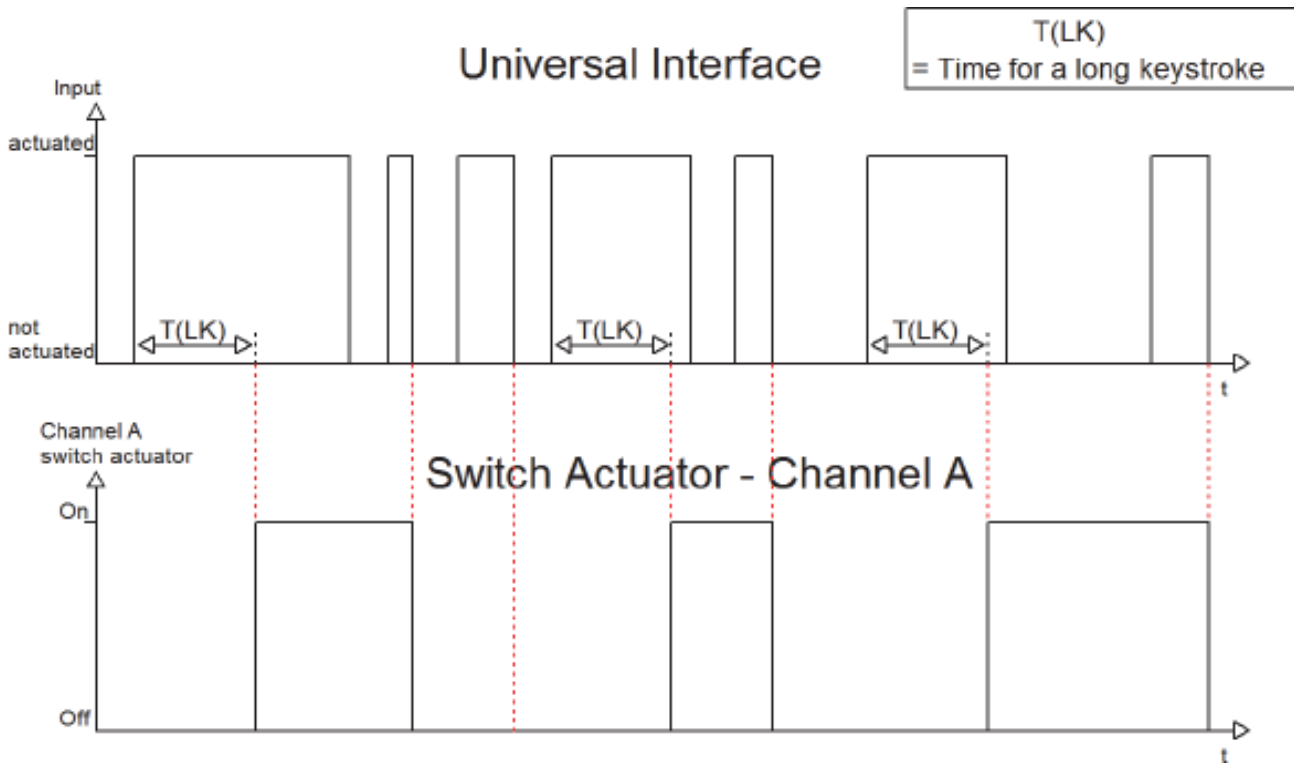

Picture 22: Long press / short press fit

The following form describes the parameters of send value:

Parameter Name	Range [Default]	Remarks
Value for keystroke short/long	Send value	Subfunction selected as send value.
Send value	<ul style="list-style-type: none"> <li>1 Byte-Value[0...255]</li> <li>Scene number</li> </ul>	Value selection: one is 1-byte unsigned value, the other is scene value.
1 Byte-Value[0...255]	0-255 [0]	A byte has no sign value, ranging from 0 to 255. It can be used for absolute dimming and other controls.
Scene number	1-64 [1]	One byte scene value, range 1 to 64. Can be used for scene control.

Form 28: Send value parameter

## 4.5.4 One button Dimming

Single key for dimming, on / off .

The following figure shows the parameter options:

The image shows a configuration interface with two dropdown menus. The first dropdown is labeled 'Function' and is set to 'One Button Dimming'. The second dropdown is labeled 'Blocking Object' and is set to 'Inactive'.

Picture 23: Single key dimming parameters

Parameter Description:

Parameter Name	Range [Default]	Remarks
Blocking object	<ul style="list-style-type: none"> <li>• Inactive</li> <li>• Active</li> </ul>	Blocking object

Form 29: one button dimming parameter

Object Description:

NO.	Name	Length	Remarks
0	Dimming on/off	1 bit	The same as the switch function, the short key is effective, and each time it is flipped.
1	Dimming	4 bit	Relative dimming, long button effective
2	Value for toggle	1 bit	Receive channel status value.

form 30: Single key dimming object

Single button dimming can achieve on / off, dimming function. The same function is used for short keystrokes and switches. Each button is turned over. Long keys achieve relative dimming. When the maximum / minimum value is reached, the brightness changes no longer, and the key stops dimming. Because single keys dimming, each time the long button dimming changes direction. Assuming that the current dimming direction is upward, the next dimming direction is downward. The dimming step is 100%. per time.



The following figure is the dimming description:

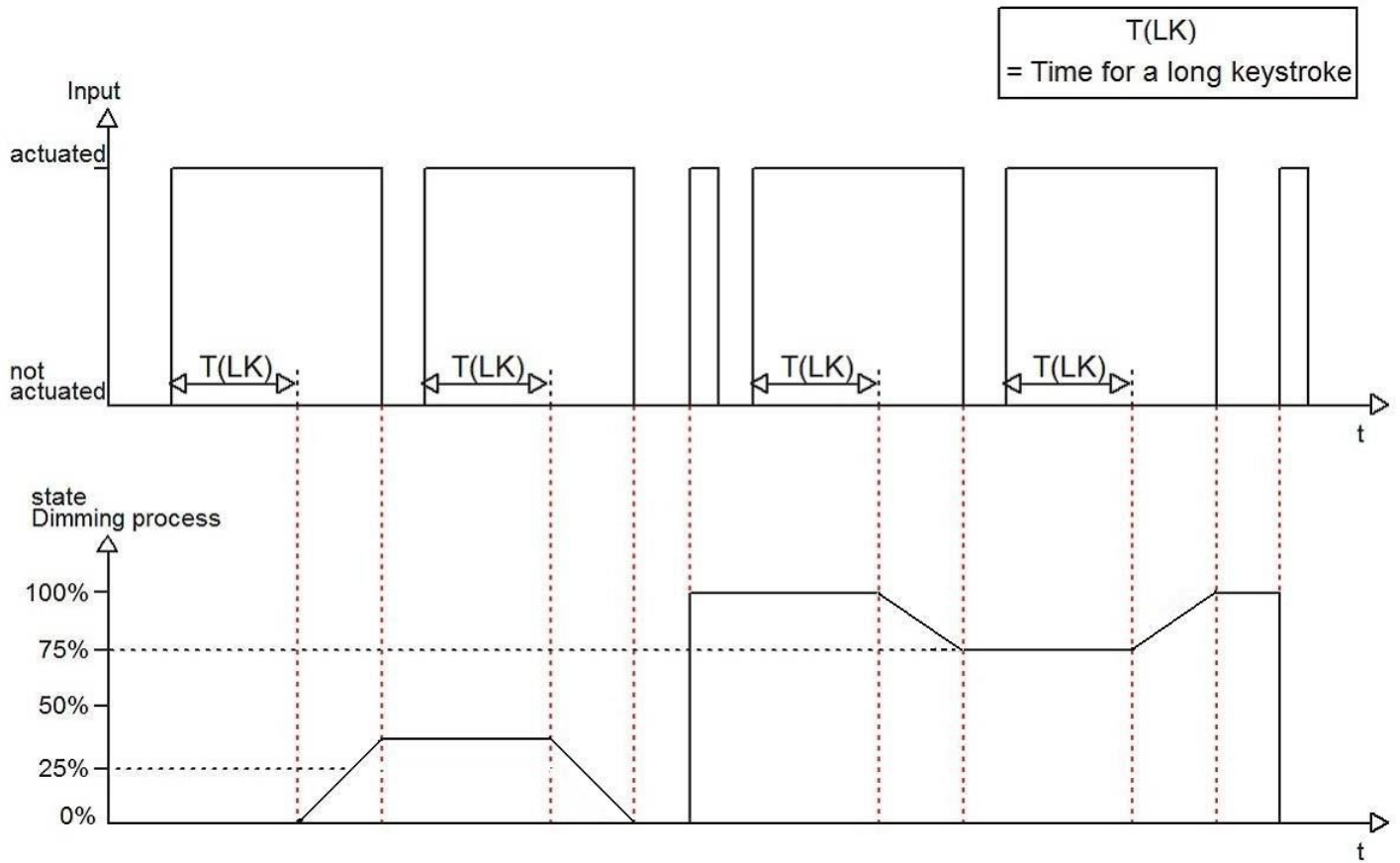

Picture 24: one button dimming

## 4.5.5 One button Shutter

Single key curtain control.

The figure below shows the parameters:

Function	One Button Shutter
Operation function	Long=move / short=stop/slats
Blocking Object	Inactive

Picture 25: shutter control

Parameter Description:

Parameter Name	Range [Default]	Remarks
Blocking object	<ul style="list-style-type: none"> <li>Inactive</li> <li>Active</li> </ul>	Blocking function

Form 31: shutter parameter

Object Description:

NO.	Name	Length	Usage
0	Shutter	1 bit	Shutter moving, long button effective.
1	Blinds/Stop	1 bit	Curtain stop, short button effective.
2	Value for change of direction	1 bit	Indicates the current direction.

Form 32: shutter object

The long button controls the curtain movement, changing the direction every time. Assuming the current upward movement, the next downward movement. The short button sends the stop command through the object blinds / stop.

## 4.6 Logic

The device consists of four logic control blocks. Each logic block can be configured with two external logic objects and device keys as input, close for logic and / or operation, and then output switch signal, byte value, or scene value.

Logic operation can be used in the situation of conditional selection. For example, a lamp can only be turned on when both external signals are 1, then the control signal can be output after the two signals are logically and operated, then the lamp will only be on when both external signals are 1.

Parameter diagram:

**Settings for logic**

Behaviour at Bus power up	<input type="text" value="no read ext. logic objects"/>
Settings for logic 1	<input type="text" value="And"/>
objecttype 1	<input type="text" value="Switch"/>
Sending condition	<input type="text" value="not automatic"/>
Output inverted	<input type="text" value="No"/>
Settings for logic 2	<input type="text" value="Or"/>
objecttype 2	<input type="text" value="Scene"/>
Scene Number	<input type="text" value="2"/>

Picture 27: Logical block function configuration

Parameter Description:

Parameter Name	Range [Default]	Remarks
Behavior at bus power up	<ul style="list-style-type: none"> <li><b>No read ext.logic objects</b></li> <li>Read ext.logic objects</li> </ul>	Specifies whether to read the logical object value when the device is powered on. When configured to power on, the device reads and updates the value of the external logical object, otherwise the default value is 0.

Form 35: Power on configuration of logic block

The following form shows the function selection:

Setting per logic [default value]	Dynamic range [default value]	Remarks
<ul style="list-style-type: none"> <li><b>Disabled</b></li> <li>And</li> </ul>	<ul style="list-style-type: none"> <li><b>Switch</b></li> <li>Scene</li> </ul>	The logical object can be configured as an and / or operation. There are three optional functions: switch / scene / 1byte value

• Or	• 1 byte value
------	----------------

Form 36: functions selection

Object Description:

NO.	Name	Length	Usage
40	Logic input 1A	1 bit	External logic input object, valid when activated
41	Logic input 1B	1 bit	External logic input object, valid when activated
42	Logic output 1	1 bit	Logical output object, valid when switch function is activated
42	Logic output 1 Scene	1 byte	Logical output object, valid when scene or 1 byte value is activated.

Form 37: logical object

There are four groups of logical objects in total, and the other three groups are numbered from 43 to 51. The functions are the same as above.

When a logic block is activated, a new parameter configuration box will appear. More parameters can be selected. Two external logic objects can choose whether to activate or not. After activation, the corresponding object can configure the group address. In addition, all channels of the device can choose whether to join the logical operation.

The following figure shows the input options, including two external logical objects and eight channels:

The image shows a configuration interface with a light blue background. It contains ten rows, each with a label on the left and a dropdown menu on the right. The labels are: 'Logical object 1 A (external)', 'Logical object 1 B (external)', 'Button 1', 'Button 2', 'Button 3', 'Button 4', 'Button 5', 'Button 6', 'Button 7', and 'Button 8'. The dropdown menus for 'Logical object 1 A' and 'Logical object 1 B' are set to 'disabled' and 'normally active' respectively. All other dropdown menus are set to 'disabled'.

Picture 28: output configuration

## 4.6.1 Logic object type switch

The following form is the parameter description:

Parameter Name	Range [Default]	Remarks
Send condition	<ul style="list-style-type: none"> <li>• <b>Not automatic</b></li> <li>• Change of input</li> <li>• Change of output</li> </ul>	Set output conditions.
Output inverted	<ul style="list-style-type: none"> <li>• <b>No</b></li> <li>• Yes</li> </ul>	Set whether the output is reversed.

Form 38: switch function

For the transmission condition change of input, when any active input state changes, the output state will be output. For the transmission condition change of output, the output state will be output only when all input signals are set to a different state after logical operation. For the reverse output function, when the logical operation result is 0, output 1, output 0.

The following figure shows the signal description. The logic function is configured as switch, and operation, activation channel A / B, and an external logic object. The output is reversed:

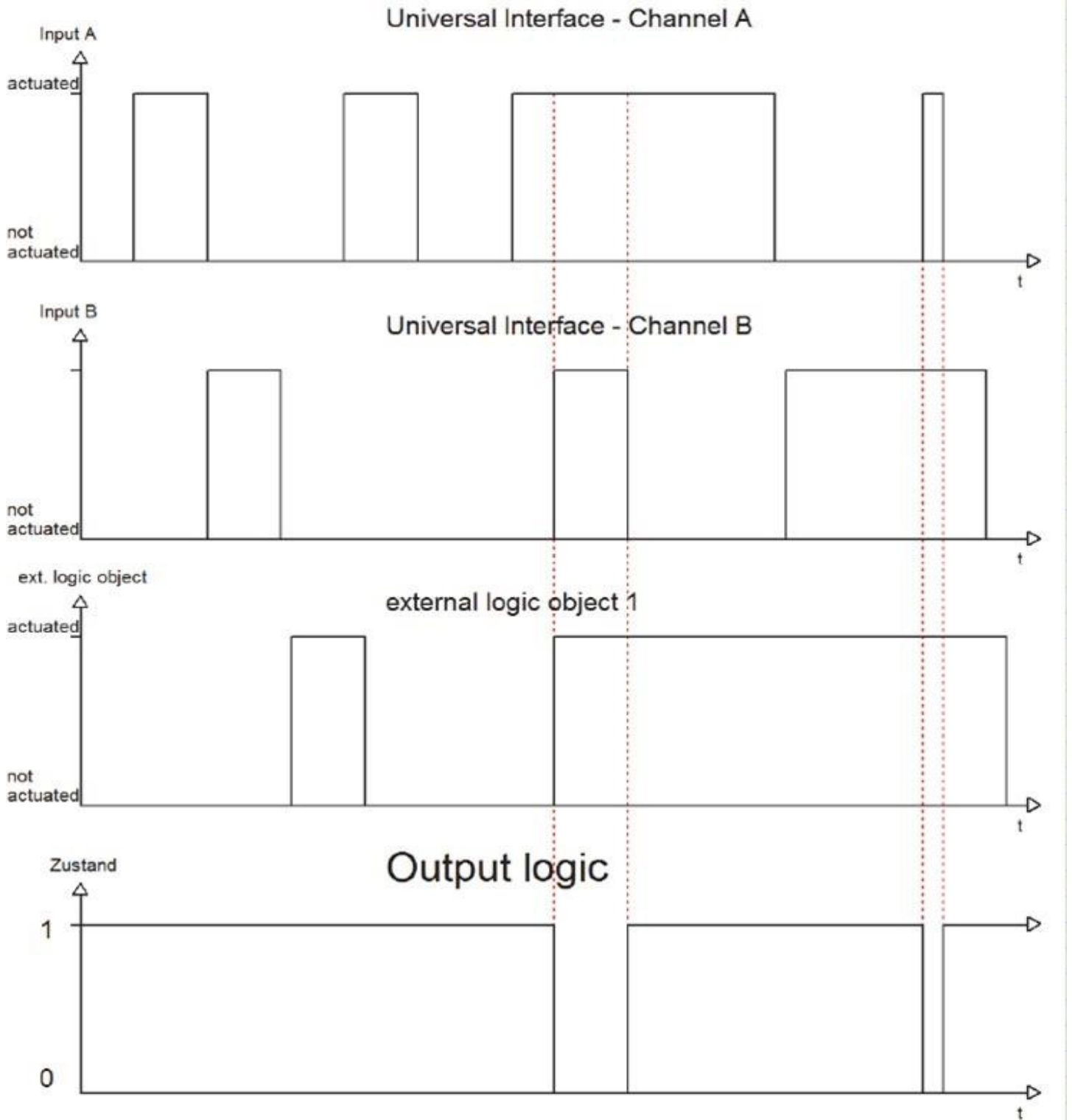

Picture 29: Logical output

In the above figure, only when the three inputs are all 1, the result of the and operation is 1, the output is 0 after reversing, and the output is 1 at other times.

## 4.6.2 Logic object type scene

After the logical block is configured as the scene function, when the logical operation result is 1, the set scene value will be output, and only when the logical operation result changes from 0 to 1 each time, the scene value will be output once.

The following form is the parameter description:

Parameter Name	Range [Default]	Remarks
Scene number	1-64 [2]	Scene number setting.

Form 39: Logical scene

## 4.6.3 Logic object type byte value

The following form is byte value parameters:

Parameter Name	Range Default]	Remarks
Byte value[0...255]	0-255 [0]	Byte value sent

Form 40: byte value

The same as the scene function, as long as the logical operation result is 1, the set byte value will be output once.

## 4.7 LED instructions

LED light can be used to indicate key action, light status and signal light as any other status indication. Two colors (Orange / white) can be configured. The following figure is led parameter configuration diagram:

LED 1 (top row left) reacts at:	no function ▼
LED 2 (top row right) reacts at:	no function ▼
LED 3 (2. row left) reacts at:	no function ▼
LED 4 (2. row right) reacts at:	no function ▼
LED 5 (3. row left) reacts at:	no function ▼
LED 6 (3. row right) reacts at:	no function ▼
LED 7 (bottom left) reacts at:	no function ▼
LED 8 (bottom right) reacts at:	no function ▼
Behaviour of LEDs at Bus power up	No read LED objects ▼

picture 30: LED configuration

Each button contains a two-color LED lamp, which can be flexibly configured as required.



## 4.7.1 LED Configuration

The following figure shows two LED configurations:

LED 1 (top row left) reacts at: external object

LED characterization (value OFF/ON): off / orange

State of green LED at ON: Permanent

State of red LED at ON: Permanent

LED 2 (top row right) reacts at: Buttons activation

LED characterization (value OFF/ON): off / orange

State of green LED at ON: Permanent

State of red LED at ON: Permanent

Picture 31: button LED configuration

The following form describes the LED parameters:

Subfunction	Range [Default]	Remarks
LED X reacts at:	<ul style="list-style-type: none"> <li>no function</li> <li>external object</li> <li>internal object</li> <li>button activation</li> </ul>	Enable led function, select LED indication signal source.
Select of the object number	0-51 [0]	When the LED indicator signal comes from the internal object, select the object number.
LED characterization(value OFF/ON)	<ul style="list-style-type: none"> <li>off/orange</li> <li>off/white</li> <li>orange/white</li> <li>white/orange</li> <li>orange/off</li> <li>white/off</li> </ul>	Select the corresponding relationship between LED display color and signal value.
State of orange LED at ON	<ul style="list-style-type: none"> <li>permanent</li> <li>blinking</li> </ul>	Indicator orange light on mode, normally on / flashing.
State of white LED at ON	<ul style="list-style-type: none"> <li>permanent</li> <li>blinking</li> </ul>	Indicator white light on mode, normally on / flashing.

Form 41: LED parameter

All LED lights have four function options:

- **no function**  
The LED light is prohibited and no status indication is made.
- **external object**  
The LED is configured to respond to external signals, and an external object will appear in the object window. The object must be associated with the external signal through the group address, so that the LED can indicate according to the external signal.
- **internal object**  
When the LED is configured to respond to the internal object, the function is the same as that of the external object, except that the signal comes from the object of the device itself, and the object does not need to be associated through the group address, but through the object number.
- **button activation**  
When the selection key is activated, the LED light will be displayed according to the key status, press 1, release 0. When all the LED lights are on, they can be independently configured to be normally on / flashing.