

Control Panel (E1 Series)

Manual-Ver2.1

MK1208



MK1208

Catalog

1 Overview.....	1
2 Product and Function Overview.....	1
2.1 Product description.....	1
2.2 Function description.....	1
3 Detailed parameters.....	1
4 Dimensional drawing and wiring diagrams.....	2
5 Product operation and installation instructions.....	3
5.1 Product operation instructions.....	3
5.2 Product installation instructions.....	4
6 Parameter setting and communication object description.....	4
6.1 Parameter setting instructions.....	4
6.1.1 Select "switch"	6
6.1.2 Select "blind"	7
6.1.3 Select "blind position"	7
6.1.4 Select "Dimming"	8
6.1.5 Select "dimming position"	9
6.1.6 Select "Scene"	10
6.1.7 Select "Value Send"	11
6.1.8 "Status LED "	12
6.1.9 "Backlight "	12
6.1.10 "Other function"	错误! 未定义书签。
6.1.11 " For KNX bus"	错误! 未定义书签。
6.2 Communication object description.....	14
6.2.1 "switch" mode.....	14
6.2.2 "blind" mode.....	15
6.2.3 "blind position" mode.....	15
6.2.4 "dimming" mode.....	16
6.2.5 "dimming position" mode.....	16
6.2.6 "scene" mode.....	17
6.2.7 " Value send " function.....	17
6.2.8 Feedback object function.....	18
6.2.9 Status light brightness function.....	18
6.2.10 Backlight brightness function.....	19
6.2.11 Device lock function.....	19
7 Safe use and maintenance.....	20
8 Contact.....	20

1 Overview

This manual provides you with detailed technical information for the control panel, including installation and programming details, and explains how to use the control panel based on practical examples. The control panel is installed in the standard 86 bottom box, which is easy to install and remove

Control panel can be used to control switches, dimming, scenes, blinds, etc.

The system is installed with other loads through the EIB/ KNX bus.

Set up and operate the whole system using engineering design tool software ETS.

2 Product and Function Overview

2.1 Product description

The control panel is mainly used in the building control system. It is installed together with other devices on the bus to form a system. The operation is simple and intuitive. Users can plan and execute these functions systematically according to their needs.

The control panel can be used to control switches, dimming, blinds, etc. Each channel on the panel includes buttons and LED indicators.

The control panel is a standard 86 bottom box installation device with 1-6 button outputs. Connect to the EIB / KNX system through the EIB bus and use the engineering design tool software ETS software (version ETS4 or above) to assign physical addresses and group addresses and set parameters.

The control panel is connected directly to the bus via the terminal block and does not require additional supply voltage. Each channel of the panel can use the various functions described above and is independent of each other.

2.2 Function description

- (1) It can be used to switch lighting, open and close curtains, raise and lower projection screens, etc., with long press, short press and reverse functions;
- (2) It can control the dimming equipment, and has the function output of relative dimming and absolute dimming;
- (3) 8bit scene control can be carried out, and the set scene function can be called;
- (4) It is possible to send values, sending 1bit/1byte values;
- (5) With LED indication function, multiple display states can be selected, such as: normally open, normally closed, flashing...
- (6) With functions of LED interlock grouping and LED brightness adjustment;
- (7) The programming mode can be entered by key operation, and the data can be downloaded without removing the product from the wall;
- (8) The status and backlight LEDs have the functions of brightness wake-up and delayed extinguishing. The wake-up conditions include key presses, object triggers, etc.

3 Detailed parameters

Bus voltage	21-30 VDC, power from KNX bus
Bus current	≤12mA
Bus power	≤360mW
Shell material	Metal +PC

Dimension (H x W x D)	86 X 86 X 33 mm
Weight (approx.)	Approx. 0.2kg
Installation method	86 bottom box
Operating temperature	-5°C- 45°C
Storage temperature	- 25°C- 55°C
Transport temperature	- 25°C- 70°C
Relative humidity	max 90%

4 Dimensional drawing and wiring diagrams

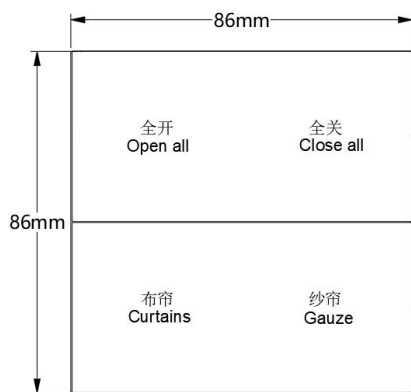

4 Key panel dimensional drawing

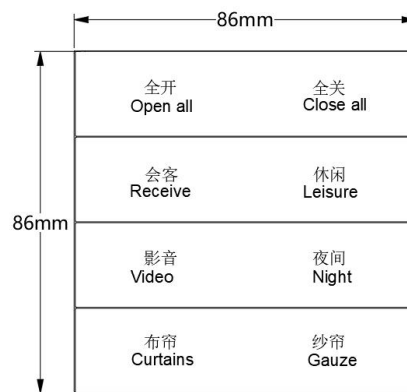
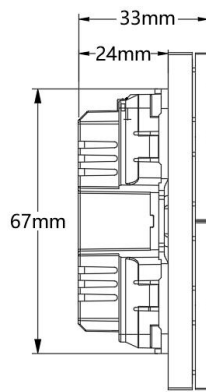

8 Key panel dimensional drawing

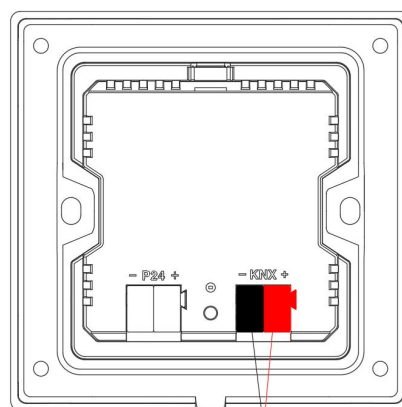
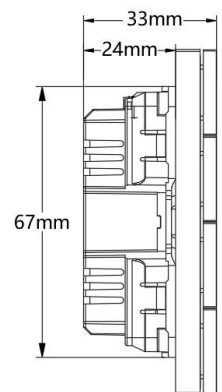

wiring diagram

5 Product operation and installation instructions

5.1 Product operation instructions

Four-key panel operation instructions

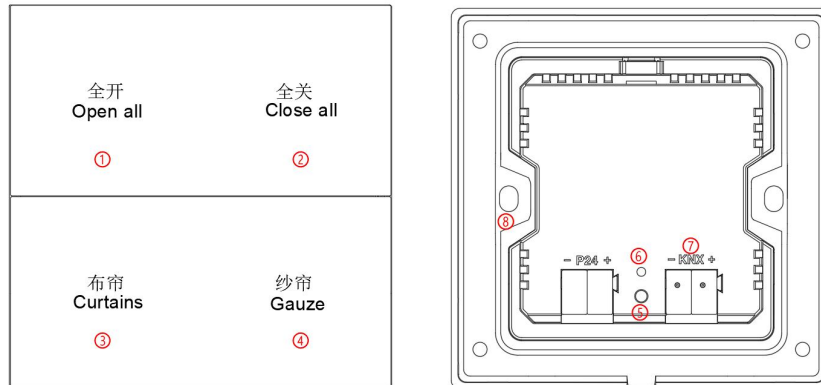

- (1) Description: Channel A;
- (2) Description: Channel B;
- (3) Description: Channel C;
- (4) Description: Channel D, Each button has a feedback LED light, and each button needs to be engraved to transmit light;
- (5) Description: Programming buttons, used to illuminate programming lights;
- (6) Description: Programming indicator, the indicator lights up red when entering the programming state, the indicator goes out automatically when it is programming;
- (7) Description: KNX bus terminal;
- (8) Description: Fixing bracket for 86 box installation.

Eight-key panel operation instructions

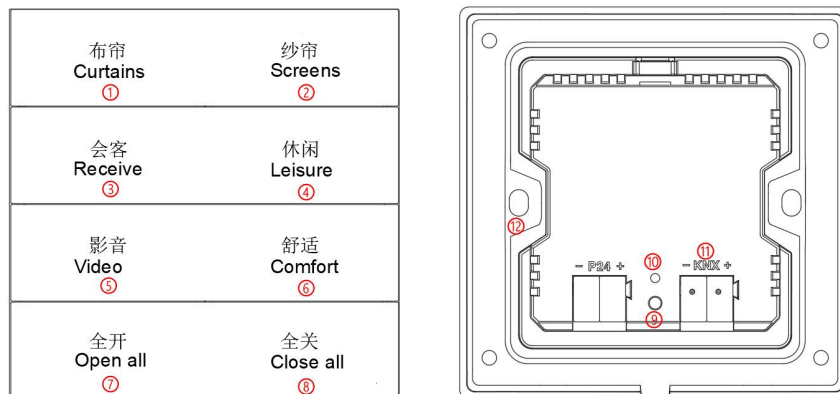

- (1) Description: Channel A;
- (2) Description: Channel B;
- (3) Description: Channel C;
- (4) Description: Channel D;

- (5) Description: Channel E;
- (6) Description: Channel F;
- (7) Description: Channel G;
- (8) Description: Channel H, each button has a feedback LED light, and each button needs to be engraved to transmit light;
- (9) Description: Programming buttons, used to illuminate programming lights;
- (10) Description: Programming indicator, the indicator lights up red when entering the programming state, the indicator goes out automatically when it is programming;
- (11) Description: KNX bus terminal;
- (12) Description: Fixing bracket for 86 box installation.

5.2 Product installation instructions

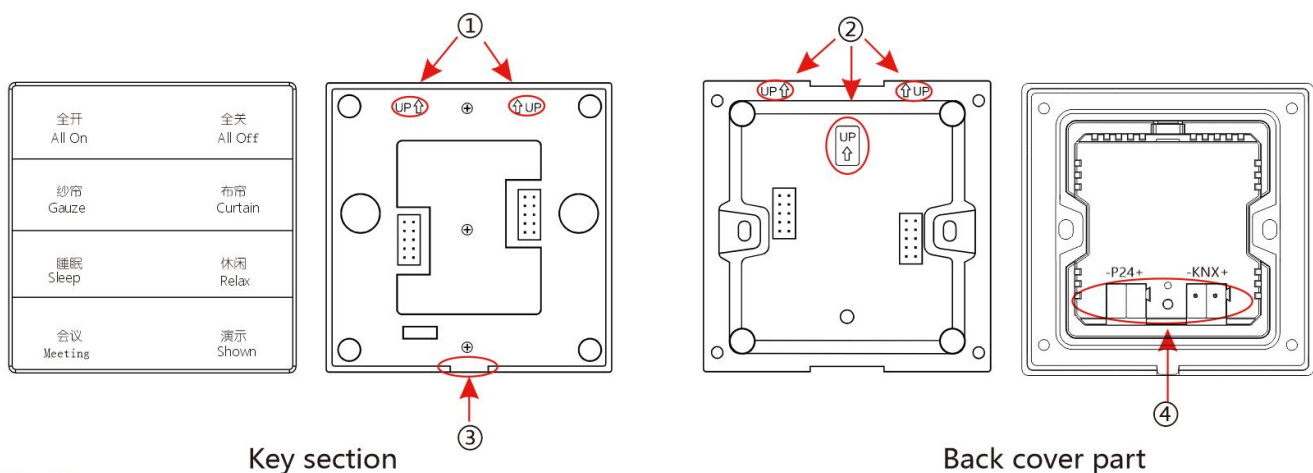

Warning: ①&② is upward; ③&④ is downward. It should keep the same direction, when the key part and back part install together. If not, It will cause the damage of product. You should bear the consequences.

- (1) Take off the back cover (the part where the back cover of the panel is embedded with the fixing frame) and install it on the standard 86 bottom box (this product does not need to remove the fixing bracket separately, install the back cover and the fixing frame together on the Standard 86 bottom box), tighten the fixing screws;
- (2) Snap the button part into the fixed back cover part, that is, the installation is successful;
- (3) When removing the panel from the bottom box, use a flat-blade screwdriver to gently pry the fixing bracket at the groove at the lower end of the panel;

6 Parameter setting and communication object description

6.1 Parameter setting instructions

The following uses ETS5 as an example. Set parameters in ETS5. Note: In the following description, Channel X or X represents the output of the corresponding channel. (Here is a 6-key control panel as an example)

1) Parameter: "configuration (as the same time)" represents the configuration when multiple keys are pressed at the same time, options: only one channel can work; all channel can work. **(This parameter doesn't work)**

2) Open the control panel parameter setting interface in ETS5, as shown in Figure 6.1.1.

Options: Disabled, Enabled

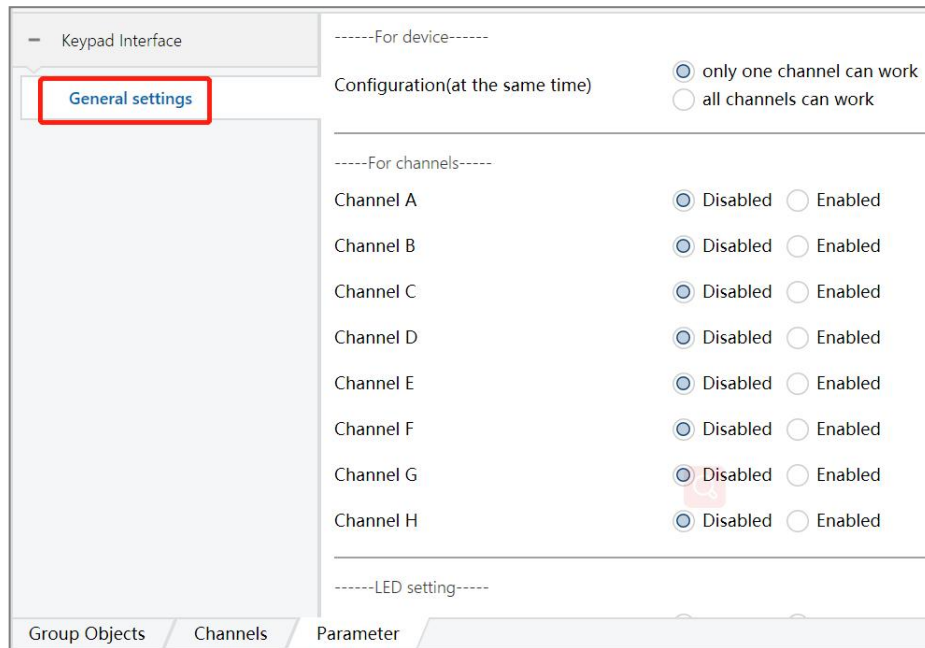

Figure 6.1.1

3) Select "Enable" for Channel X, the interface is shown in Figure 6.1.2, and 8 channel options in the red block as shown in figure.

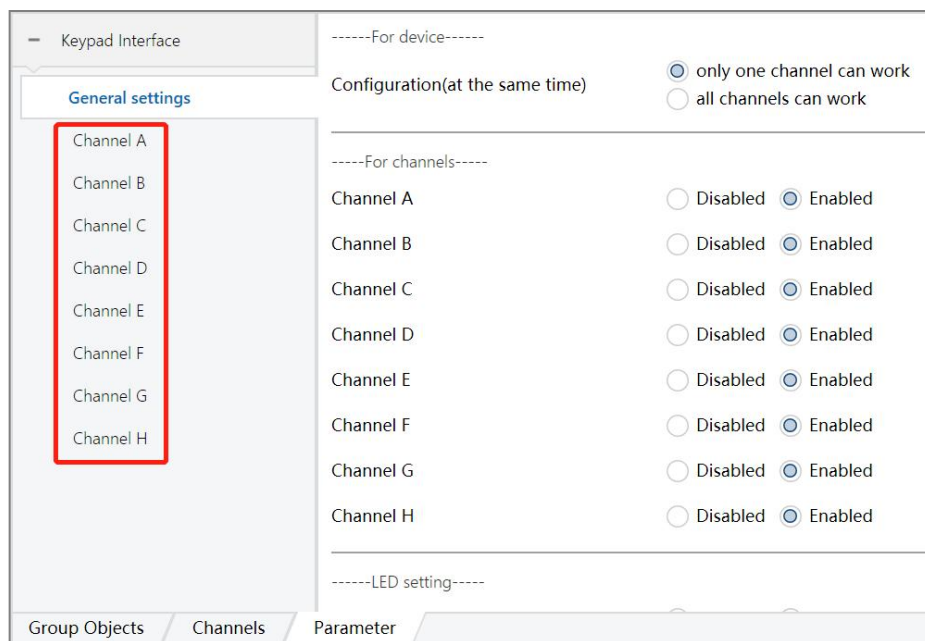

Figure 6.1.2

4) Click the options in the red block above to set the parameters of each channel, as shown in figure 6.1.3

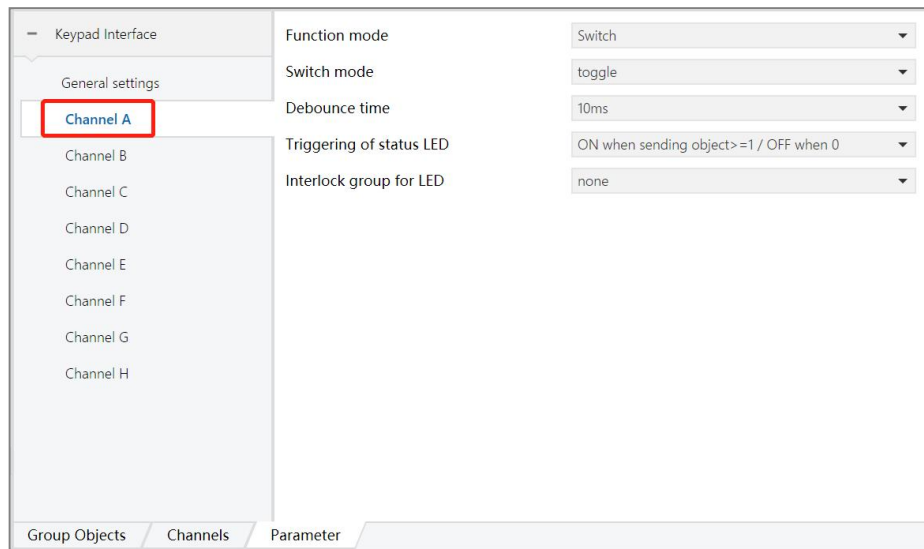

Figure 6.1.3

Function mode, options:

Switch: Switch, used to controlling the on / off state of the lamp by the switch actuator;

Blind: Blind, used to control the opening / closing state of window blinds, curtains, etc.

Blind position: Blind position, used to control the absolute opening / closing position of curtain actuators on blinds, curtains, etc.;

Dimming: Dimming, used to control the brightness adjustment of the dimming actuator;

Dimming position: Dimming position, used to control the adjustment of the absolute value of the dimming actuator;

Scene: Scene, for recalling scenes in switches, dimming, curtain actuators.

6.1.1 Select “switch”

Parameter	Description
Switch mode	Switch mode, options: always on, always off, toggle(On / off reverse switching), user define
Debounce time	Debounce time, options: 10ms, 20ms.....100ms
Triggering of status LED	LED indicator activation mode, options: (1) always on; (1) always off; (2) always flashes; (3) press =ON/release=OFF; (4) press =OFF/release=ON; (5) press =flashes/release=OFF; (6) press =flashes/release=ON; (7) Flashes three times, then OFF; (8) Flashes three times, then ON; (9) ON when sending object >=1; OFF when 0 (10) OFF when sending object >=1; ON when 0; (11) flashes when sending object >=1; OFF when 0; (12) OFF when sending object >=1; flashes when 0; (13) ON when feedback object=1; OFF when 0; (14) OFF when feedback object=1; ON when 0; (15) flashes when feedback object=1; OFF when 0;

	(16) OFF when feedback object=1; flashes when 0; (17) ON when scene object=number/OFF when no equal (When the scene number of the data on the bus is the same as the scene number set on the channel, the indicator is on, and the indicator is off when it is not waiting) ;
Read feedback object at voltage recovery	Read feedback object after voltage recovery, options: yes, no
Interlock group for LED	Interlock group for LED, options: none, group 1, group 2, group 3, group 4

6.1.2 Select “blind”

Parameter	Description
Blind mode	Blind mode, options: always up, always down, toggle (Rise / fall reverse switch) .
Long operation	Long operation, options: yes, no; When yes is selected, parameter “long operation after:” will appear, data can be sent after a long press, options: 0.5s, 1s, 2s.....7s. Parameter “the interval of data (base:0.1s)” represents the time interval between continuous data sending when long press; can be filled in 0~255;
The interval of data(base:0.1s)	The interval time of data (unit: 0.1s) , can be filled in: 0-255
Debounce time	Debounce time, options: 10ms, 20ms.....100ms
Triggering of status LED	LED indicator activation mode, options: (1) always on; (2) always off; (3) always flashes; (4) press =ON/release=OFF; (5) press =OFF/release=ON; (6) press =flashes/release=OFF; (7) press =flashes/release=ON; (8) Flashes three times, then OFF; (9) Flashes three times, then ON; (10) ON when sending object>=1; OFF when 0; (11) OFF when sending object>=1; ON when 0; (12) flashes when sending object>=1; OFF when 0; (13) OFF when sending object>=1; flashes when 0; (14) ON when feedback object=1; OFF when 0; (15) OFF when feedback object=1; ON when 0; (16) flashes when feedback object=1; OFF when 0; (17) OFF when feedback object=1; flashes when 0; (18) ON when scene object=number/OFF when no equal (When the scene number of the data on the bus is the same as the scene number set on the channel, the indicator is on, and the indicator is off when it is not waiting) .
Interlock group for LED	Interlock group for LED, options: none, group 1, group 2, group 3, group 4

6.1.3 Select “blind position”

Parameter	Description
-----------	-------------

Blind position mode	Blind absolute position mode, options: position value 1, position toggle, user define; When position value 1 is selected, parameter "send value 1" (output 1) will appear, options: 0%, 1%, 2%.....100%; When "position toggle" is selected, parameter "send value 1" (output value 1) , "send value 2" (output value 2) will appear, options: 0%, 1%, 2%.....100%; When "user define" is selected, parameter "operate when pressing" , "operate when releasing" will appear, options: yes, no, when "yes" is selected, parameter: "send value" (output value) will appear, can be filled in 0-255;
Debounce time	Debounce time, options: 10ms, 20ms.....100ms
Triggering of status LED	LED indicator activation mode, options: (1) always on; (2) always off; (3) always flashes; (4) press =ON/release=OFF; (5) press =OFF/release=ON; (6) press =flashes/release=OFF; (7) press =flashes/release=ON; (8) Flashes three times, then OFF; (9) Flashes three times, then ON; (10) ON when sending object>=1; OFF when 0; (11) OFF when sending object>=1; ON when 0; (12) flashes when sending object>=1; OFF when 0; (13) OFF when sending object>=1; flashes when 0; (14) ON when feedback object=1; OFF when 0; (15) OFF when feedback object=1; ON when 0; (16) flashes when feedback object=1; OFF when 0; (17) OFF when feedback object=1; flashes when 0; (18) ON when scene object=number/OFF when no equal (When the scene number of the data on the bus is the same as the scene number set on the channel, the indicator is on, and the indicator is off when it is not waiting) .
Interlock group for LED	Interlock group for LED, options: none, group 1, group 2, group 3, group 4

6.1.4 Select "Dimming"

Parameter	Description
Dimming mode	Dimming mode, options: dimming up, dimming down, dimming toggle (Inverted switching of brightness increase / decrease) .
Long operation after:	Send data after long press, options: 0.5s, 1s, 2s.....7s.
Transmission mode for long operation	Transmission mode for long operation, options: cyclic transmission, one-time transmission; when "cyclic transmission" is selected, parameter "the interval of data (base: 0.1s) " will appear, represents the time interval between continuous data sending when long press; can be filled in 0~255.
Step dimming	Dimming level output percentage, options: 1%, 3%, 6%, 12%, 25%, 50%,100%
Send stop instruction	Send stop command when released, options: Yes, No

when releasing	
Debounce time	Debounce time, options: 10ms, 20ms.....100ms
Triggering of status LED	LED indicator activation mode, options: (1) always on; (2) always off; (3) always flashes; (4) press =ON/release=OFF; (5) press =OFF/release=ON; (6) press =flashes/release=OFF; (7) press =flashes/release=ON; (8) Flashes three times, then OFF; (9) Flashes three times, then ON; (10) ON when sending object>=1; OFF when 0; (11) OFF when sending object>=1; ON when 0; (12) flashes when sending object>=1; OFF when 0; (13) OFF when sending object>=1; flashes when 0; (14) ON when feedback object=1; OFF when 0; (15) OFF when feedback object=1; ON when 0; (16) flashes when feedback object=1; OFF when 0; (17) OFF when feedback object=1; flashes when 0; (18) ON when scene object=number/OFF when no equal (When the scene number of the data on the bus is the same as the scene number set on the channel, the indicator is on, and the indicator is off when it is not waiting) .
Interlock group for LED	Interlock group for LED, options: none, group 1, group 2, group 3, group 4.

6.1.5 Select “dimming position”

Parameter	Description
Dimming position mode	Absolute dimming mode, options: position value 1, position toggle, user define; When position value 1 is selected, parameter “send value 1” (output value 1) will appear, options: 0%, 1%, 2%.....100%; When “position toggle” is selected, parameter “send value 1” (output value 1) , “send value 2” (output value 2) will appear, options: 0%, 1%, 2%.....100%; When “user define” is selected, parameter “operate when pressing” , “operate when releasing” will appear, options: yes, no, when “yes” is selected, parameter: “send value” (output value) will appear, can be filled in 0-255;
Debounce time	Debounce time, options: 10ms, 20ms.....100ms
Triggering of status LED	LED indicator activation mode, options: (1) always on; (2) always off; (3) always flashes; (4) press =ON/release=OFF; (5) press =OFF/release=ON; (6) press =flashes/release=OFF;

	<p>(7) press =flashes/release=ON; (8) Flashes three times, then OFF; (9) Flashes three times, then ON; (10) ON when sending object>=1; OFF when 0; (11) OFF when sending object>=1; ON when 0; (12) flashes when sending object>=1; OFF when 0; (13) OFF when sending object>=1; flashes when 0; (14) ON when feedback object=1; OFF when 0; (15) OFF when feedback object=1; ON when 0; (16) flashes when feedback object=1; OFF when 0; (17) OFF when feedback object=1; flashes when 0; (18) ON when scene object=number/OFF when no equal (When the scene number of the data on the bus is the same as the scene number set on the channel, the indicator is on, and the indicator is off when it is not waiting) .</p>
Interlock group for LED	Interlock group for LED, options: none, group 1, group 2, group 3, group 4

6.1.6 Select "Scene"

Parameter	Description
Scene mode	<p>Scene mode, options: scene number, scene toggle, user define. When scene number 1 is selected, parameter "scene value 1" will appear, can be filled in: 1~64; When "scene toggle" is selected, parameter "scene value 1" , "scene value 2" will appear, can be filled in: 1~64; When "user define" is selected, parameter "operate when pressing" , "operate when releasing" will appear, options: yes, no, when "yes" is selected, parameter "send value" (output value) will appear, can be filled in: 1~64;</p>
Debounce time	Debounce time, options: 10ms, 20ms.....300ms
Triggering of status LED	<p>LED indicator activation mode, options: (1) always on; (2) always off; (3) always flashes; (4) press =ON/release=OFF; (5) press =OFF/release=ON; (6) press =flashes/release=OFF; (7) press =flashes/release=ON; (8) Flashes three times, then OFF; (9) Flashes three times, then ON; (10) ON when sending object>=1; OFF when 0; (11) OFF when sending object>=1; ON when 0; (12) flashes when sending object>=1; OFF when 0; (13) OFF when sending object>=1; flashes when 0; (14) ON when feedback object=1; OFF when 0; (15) OFF when feedback object=1; ON when 0;</p>

	<p>(16) flashes when feedback object=1; OFF when 0;</p> <p>(17) OFF when feedback object=1; flashes when 0;</p> <p>(18) ON when scene object=number/OFF when no equal (When the scene number of the data on the bus is the same as the scene number set on the channel, the indicator is on, and the indicator is off when it is not waiting) .</p>
Interlock group for LED	Interlock group for LED, options: none, group 1, group 2, group 3, group 4

6.1.7 Select “Value Send”

Parameter	Description
Value send	Value send;
Data type for value	Data type for value, The options are: 1bit、1byte; ①When "1bit" is selected, the parameter "Value for sending" is value sending, and the options are: Off, On; ② When "1byte" is selected, the parameter "Value for sending", and the options are: 0~255.
Long operation	Long operation , The options are: No, Yes, when "Yes" is selected, ① parameter "Long operation after", optional: 0.5s, 1s4s; ② parameter "Data type for long operation", optional: 1bit, 1byte; when "1bit" is selected, the parameter "Value for sending", optional: Off, On; when "1byte" is selected, the parameter "Value for sending", optional: 0~255.
Debounce time	Debounce time, options: 10ms, 20ms.....300ms
Triggering of status LED	<p>LED indicator activation mode, options:</p> <p>(1) always on;</p> <p>(2) always off;</p> <p>(3) always flashes;</p> <p>(4) press =ON/release=OFF;</p> <p>(5) press =OFF/release=ON;</p> <p>(6) press =flashes/release=OFF;</p> <p>(7) press =flashes/release=ON;</p> <p>(8) Flashes three times, then OFF;</p> <p>(9) Flashes three times, then ON;</p> <p>(10) ON when sending object>=1; OFF when 0;</p> <p>(11) OFF when sending object>=1; ON when 0;</p> <p>(12) flashes when sending object>=1; OFF when 0;</p> <p>(13) OFF when sending object>=1; flashes when 0;</p> <p>(14) ON when feedback object=1; OFF when 0;</p> <p>(15) OFF when feedback object=1; ON when 0;</p> <p>(16) flashes when feedback object=1; OFF when 0;</p> <p>(17) OFF when feedback object=1; flashes when 0;</p> <p>(18) ON when scene object=number/OFF when no equal (When the scene number of the data on the bus is the same as the scene number set on the channel, the indicator is on, and the indicator is off when it is not waiting) .</p>
Interlock group for LED	Interlock group for LED, options: none, group 1, group 2, group 3, group 4

6.1.8 "Status LED "

(1) Parameter "status LED settings" indicates the setting of status indicator, options: Disabled, Enabled; When "Enabled" is selected, the "Status LED" option appears in the red box as shown below

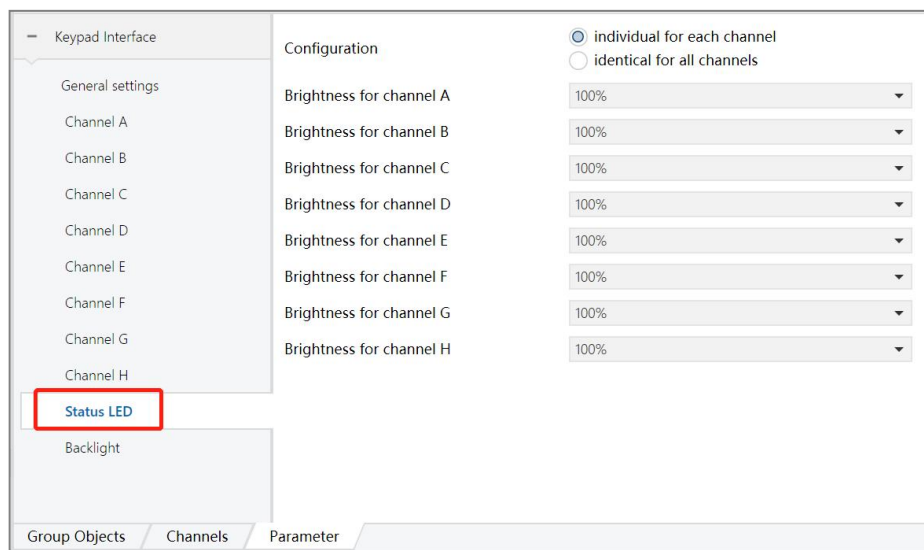
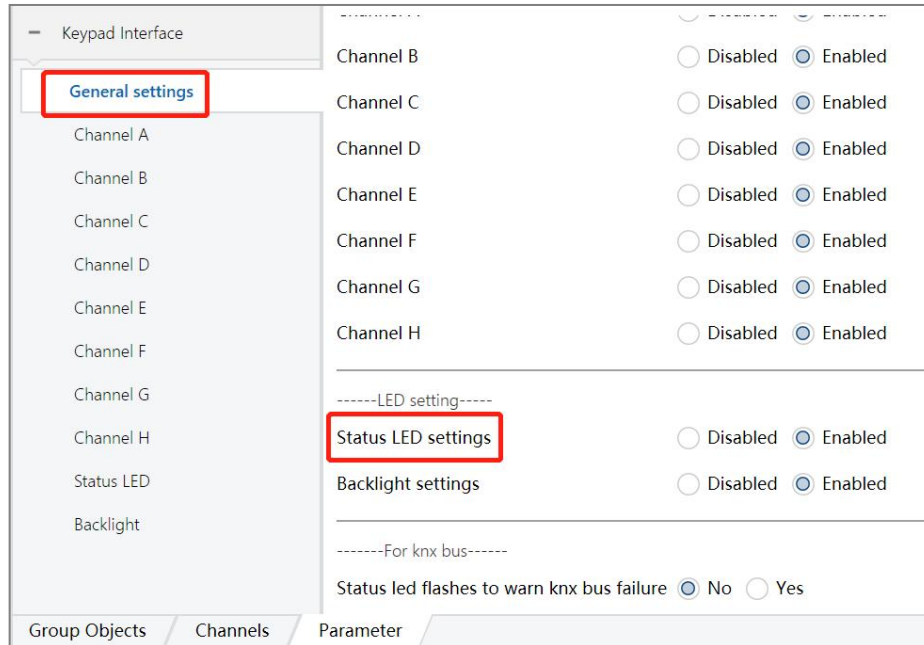

Parameter: "configuration " indicates setting for LED brightness, options: Individual for each channel; Identical for all channels.

When "Individual for each channel" is selected, parameter will appear: Brightness for channel A, Brightness for channel B.....Brightness for channel H; These parameters can be used to set the LED brightness value of each channel, options: 0%, 1%.....100%.

When "Identical for all channels" is selected, parameter will appear: Brightness for all channel; options: 0%, 1%..... 100%. Parameter: Overwrite brightness via object for all channel; options: Yes, No.

6.1.9 "Backlight "

The parameter "Backlight settings" indicates the brightness setting of the backlight. (this parameter does not work at the moment)

6.1.10 "Other function"

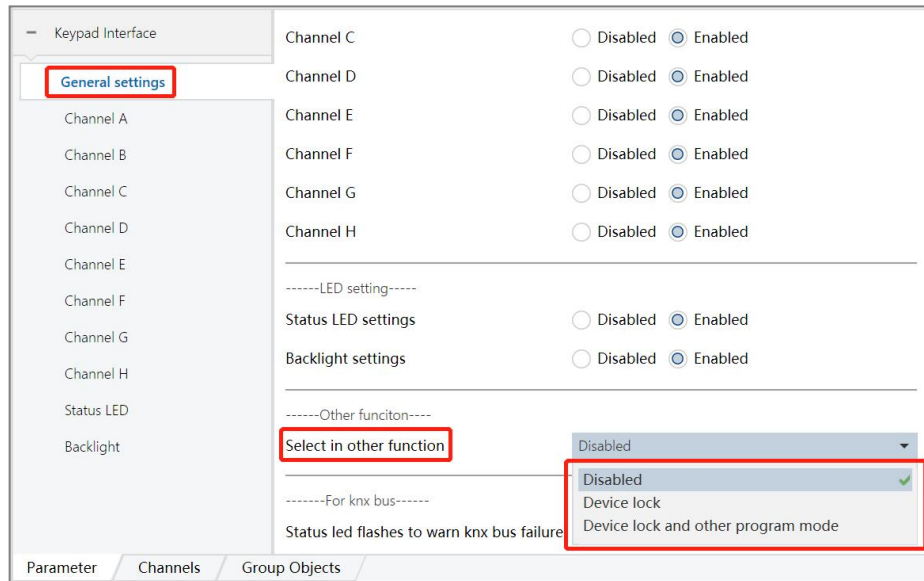

Pic 6.1.10

The parameter "Select in other function" means to select other functions, available for selection: Disabled, Device lock, Device lock and other program mode.

Press and hold two buttons at the same time for 5s to turn on/off this function (it is recommended to press and hold two buttons on two different button sheets at the same time when operating), after it is turned on, the panel enters the programming mode, and the button light keeps flashing, press the two buttons again Press the key for 5s to exit the programming mode)

Parameter	Description
Device lock	(This parameter does not work temporarily, the default is 5s to enter the programming mode)
Device lock and other program mode	(This parameter does not work temporarily, the default is 5s to enter the programming mode)

6.1.11 "For knx bus"

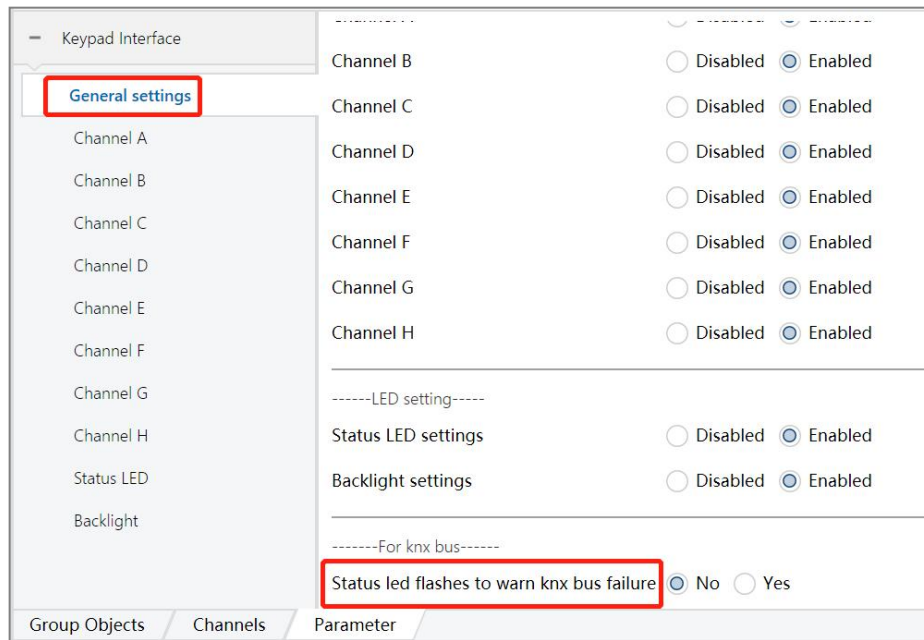

The parameter "Status led flashes to warn knx bus failure" indicates that the status LED flashes to warn of KNX bus failure. (this parameter does not work at the moment)

6.2 Communication object description

The communication object is the medium for the device to communicate with other devices on the bus, that is, only the communication object can perform bus communication. The role of each communication object is described in detail below.

Note: in the column of table properties, "C" represents the communication function enable of the communication object, "W" represents the value of the communication object can be rewritten through the bus, "R" represents the value of the communication object can be read through the bus, "T" represents the communication object has the transmission function, and "U" represents the value of the communication object can be updated.

6.2.1 "switch" mode

There are 8 objects in the "switch" mode, as shown in Figure 6.2.1. The specific functions are shown in Table 1.1.

Number	Name	Object Function	Description	Group Addr	Length	C	R	W	T	U	Data Type	Priority
0	Switch, Channel A	On / Off			1 bit	C	R	W	T	-	switch	Low
9	Switch, Channel B	On / Off			1 bit	C	R	W	T	-	switch	Low
18	Switch, Channel C	On / Off			1 bit	C	R	W	T	-	switch	Low
27	Switch, Channel D	On / Off			1 bit	C	R	W	T	-	switch	Low
36	Switch, Channel E	On / Off			1 bit	C	R	W	T	-	switch	Low
45	Switch, Channel F	On / Off			1 bit	C	R	W	T	-	switch	Low
54	Switch, Channel G	On / Off			1 bit	C	R	W	T	-	switch	Low
63	Switch, Channel H	On / Off			1 bit	C	R	W	T	-	switch	Low

Figure 6.2.1

Number	Name	Data type	Attribute
0,9,18,27,36,45,54,63	Switch, Channel X	1 bit	C,R,W,T

This communication object is enabled when the parameter "Function mode" selects "switch". This communication object is used to control the operation of the lighting switch and send ON ("1") / OFF ("0") messages.

Table 1.1

6.2.2 “blind” mode

There are 16 objects in the "blind" mode, as shown in Figure 6.2.2. The specific functions are shown in Table 1.2.

Number	Name	Object Function	Description	Group Addr	Length	C	R	W	T	U	Data Type	Priority
1	Blind, Channel A	Up / Down			1 bit	C	R	W	T	-	up/down	Low
2	Blind, Long, Channel A	Up / Down			1 bit	C	R	W	T	-	up/down	Low
10	Blind, Channel B	Up / Down			1 bit	C	R	W	T	-	up/down	Low
11	Blind, Long, Channel B	Up / Down			1 bit	C	R	W	T	-	up/down	Low
19	Blind, Channel C	Up / Down			1 bit	C	R	W	T	-	up/down	Low
20	Blind, Long, Channel C	Up / Down			1 bit	C	R	W	T	-	up/down	Low
28	Blind, Channel D	Up / Down			1 bit	C	R	W	T	-	up/down	Low
29	Blind, Long, Channel D	Up / Down			1 bit	C	R	W	T	-	up/down	Low
37	Blind, Channel E	Up / Down			1 bit	C	R	W	T	-	up/down	Low
38	Blind, Long, Channel E	Up / Down			1 bit	C	R	W	T	-	up/down	Low
46	Blind, Channel F	Up / Down			1 bit	C	R	W	T	-	up/down	Low
47	Blind, Long, Channel F	Up / Down			1 bit	C	R	W	T	-	up/down	Low
55	Blind, Channel G	Up / Down			1 bit	C	R	W	T	-	up/down	Low
56	Blind, Long, Channel G	Up / Down			1 bit	C	R	W	T	-	up/down	Low
64	Blind, Channel H	Up / Down			1 bit	C	R	W	T	-	up/down	Low
65	Blind, Long, Channel H	Up / Down			1 bit	C	R	W	T	-	up/down	Low

Table 6.2.2

Number	Name	Data type	Attribute
1,10,19,28,37,46,55,64	Blind, Channel X	1 bit	C,R,W,T
This communication object is enabled when the parameter "Function mode" selects "blind". This communication object is used to control the curtain up / down operation, sending up ("0") / down ("1") messages.			
2,11,20,29,38,47,56,65	Blind, Long, Channel X	1 bit	C,R,W,T
This communication object is enabled when the parameter "Function" selects "blind", then the parameter "long operation" appears, and "yes" is selected. This communication object is used for the long-press operation of the corresponding channel button and generally used to control the adjustment of the position of the blinds / curtains. When the communication object sends a "1" message, it jogs down; when it sends a "0" message, it jogs up.			

表 1.2

6.2.3 “blind position” mode

There are 8 objects in the "blind position" mode, as shown in Figure 6.2.3. The specific functions are shown in Table 1.3.

Number	Name	Object Function	Description	Group Address	Length	C	R	W	T	U	Data Type	Priority
3	Blind value, Channel A	8-bit Value			1 byte	C	R	W	T	-	percentage (0..100%)	Low
12	Blind value, Channel B	8-bit Value			1 byte	C	R	W	T	-	percentage (0..100%)	Low
21	Blind value, Channel C	8-bit Value			1 byte	C	R	W	T	-	percentage (0..100%)	Low
30	Blind value, Channel D	8-bit Value			1 byte	C	R	W	T	-	percentage (0..100%)	Low
39	Blind value, Channel E	8-bit Value			1 byte	C	R	W	T	-	percentage (0..100%)	Low
48	Blind value, Channel F	8-bit Value			1 byte	C	R	W	T	-	percentage (0..100%)	Low
57	Blind value, Channel G	8-bit Value			1 byte	C	R	W	T	-	percentage (0..100%)	Low
66	Blind value, Channel H	8-bit Value			1 byte	C	R	W	T	-	percentage (0..100%)	Low

Figure 6.2.3

Number	Name	Data type	Attribute
3,12,21,30,39,48,57,66	Blind value, Channel X	8 bit	C,R,W,T
This communication object is enabled when "blind position" is selected in the parameter "Function mode". This communication object is used to control the absolute position operation of the curtain, send a preset percentage, and adjust the curtain to the corresponding position.			

Table 1.3

6.2.4 "dimming" mode

There are 16 objects in the "dimming" mode, as shown in Figure 6.2.4. The specific functions are shown in Table 1.4.

	Number	Name	Object Function	Description	Group Address	Length	C	R	W	T	U	Data Type	Priority
🔌	4	Dimming switch, Channel A	On / Off			1 bit	C	R	W	T	-	switch	Low
🔌	5	Dimming level, Channel A	Brighter / Darker			4 bit	C	R	W	T	-	dimming control	Low
🔌	13	Dimming switch, Channel B	On / Off			1 bit	C	R	W	T	-	switch	Low
🔌	14	Dimming level, Channel B	Brighter / Darker			4 bit	C	R	W	T	-	dimming control	Low
🔌	22	Dimming switch, Channel C	On / Off			1 bit	C	R	W	T	-	switch	Low
🔌	23	Dimming level, Channel C	Brighter / Darker			4 bit	C	R	W	T	-	dimming control	Low
🔌	31	Dimming switch, Channel D	On / Off			1 bit	C	R	W	T	-	switch	Low
🔌	32	Dimming level, Channel D	Brighter / Darker			4 bit	C	R	W	T	-	dimming control	Low
🔌	40	Dimming switch, Channel E	On / Off			1 bit	C	R	W	T	-	switch	Low
🔌	41	Dimming level, Channel E	Brighter / Darker			4 bit	C	R	W	T	-	dimming control	Low
🔌	49	Dimming switch, Channel F	On / Off			1 bit	C	R	W	T	-	switch	Low
🔌	50	Dimming level, Channel F	Brighter / Darker			4 bit	C	R	W	T	-	dimming control	Low
🔌	58	Dimming switch, Channel G	On / Off			1 bit	C	R	W	T	-	switch	Low
🔌	59	Dimming level, Channel G	Brighter / Darker			4 bit	C	R	W	T	-	dimming control	Low
🔌	67	Dimming switch, Channel H	On / Off			1 bit	C	R	W	T	-	switch	Low
🔌	68	Dimming level, Channel H	Brighter / Darker			4 bit	C	R	W	T	-	dimming control	Low

Figure 6.2.4

Number	Name	Data type	Attribute
4,13,22,31,40,49,58,67	Dimming switch, Channel X	1 bit	C,R,W,T
This communication object is enabled when "dimming" is selected in the parameter "Function mode". This communication object is used for short-press operation of the corresponding channel button to send dimming on / off messages.			
5,14,23,41,50,59,68	Dimming level, Channel X	4 bit	C,R,W,T
This communication object is enabled when "dimming" is selected in the parameter "Function mode". This communication object is used for long-press operation of the corresponding channel, and continuously sends relative dimming commands according to the dimming level set by the VD library.			

Table 1.4

6.2.5 "dimming position" mode

There are 8 objects in the "dimming position" mode, as shown in Figure 6.2.5. The specific functions are shown in Table 1.5.

	Number	Name	Object Function	Description	Group Address	Length	C	R	W	T	U	Data Type	Priority
🔌	6	Dimming value, Channel A	8-bit Value			1 byte	C	R	W	T	-	percentage (0..100%)	Low
🔌	15	Dimming value, Channel B	8-bit Value			1 byte	C	R	W	T	-	percentage (0..100%)	Low
🔌	24	Dimming value, Channel C	8-bit Value			1 byte	C	R	W	T	-	percentage (0..100%)	Low
🔌	33	Dimming value, Channel D	8-bit Value			1 byte	C	R	W	T	-	percentage (0..100%)	Low
🔌	42	Dimming value, Channel E	8-bit Value			1 byte	C	R	W	T	-	percentage (0..100%)	Low
🔌	51	Dimming value, Channel F	8-bit Value			1 byte	C	R	W	T	-	percentage (0..100%)	Low
🔌	60	Dimming value, Channel G	8-bit Value			1 byte	C	R	W	T	-	percentage (0..100%)	Low
🔌	69	Dimming value, Channel H	8-bit Value			1 byte	C	R	W	T	-	percentage (0..100%)	Low

Figure 6.2.5

Number	Name	Data type	Attribute
6,15,24,33,42,51,60,69	Dimming value, channel X	8 bit	C,R,W,T
This communication object is enabled when the parameter "Function mode" selects "dimming position". This			

communication object is used to control the absolute brightness operation of the dimming, send a preset percentage, and adjust the brightness to the corresponding position.

Table 1.5

6.2.6 "scene" mode

There are 8 objects in the "scene" mode, as shown in Figure 6.2.6. The specific functions are shown in Table 1.6.

Number	Name	Object Function	Description	Group Address	Length	C	R	W	T	U	Data Type	Priority
7	Scene, Channel A	8-bit Value			1 byte	C	R	W	T	-	scene control	Low
16	Scene, Channel B	8-bit Value			1 byte	C	R	W	T	-	scene control	Low
25	Scene, Channel C	8-bit Value			1 byte	C	R	W	T	-	scene control	Low
34	Scene, Channel D	8-bit Value			1 byte	C	R	W	T	-	scene control	Low
43	Scene, Channel E	8-bit Value			1 byte	C	R	W	T	-	scene control	Low
52	Scene, Channel F	8-bit Value			1 byte	C	R	W	T	-	scene control	Low
61	Scene, Channel G	8-bit Value			1 byte	C	R	W	T	-	scene control	Low
70	Scene, Channel H	8-bit Value			1 byte	C	R	W	T	-	scene control	Low

Figure 6.2.6

Number	Name	Data type	Attribute
7,16,25,34,43,52,61,70	Scene, channel X	1 Byte	C,R,W,T

This communication object is enabled when the parameter "Function" selects "scene". This communication object is used to send scene control messages.

Table 1.6

6.2.7 " Value send " function

There are 16 objects in the "Value send function ", as shown in Figure 6.2.7, and the specific functions are shown in Table1.7

Number	Name	Object Function	Description	Group Address	Length	C	R	W	T	U	Data Type	Priority
6	Value send, Channel A	1-bit value			1 bit	C	R	W	T	-	switch	Low
7	Value send, Long, Channel A	1-bit Value			1 bit	C	R	W	T	-	switch	Low
15	Value send, Channel B	1-bit Value			1 bit	C	R	W	T	-	switch	Low
16	Value send, Long, Channel B	1-bit Value			1 bit	C	R	W	T	-	switch	Low
24	Value send, Channel C	1-bit Value			1 bit	C	R	W	T	-	switch	Low
25	Value send, Long, Channel C	1-bit Value			1 bit	C	R	W	T	-	switch	Low
33	Value send, Channel D	1-bit Value			1 bit	C	R	W	T	-	switch	Low
34	Value send, Long, Channel D	1-bit Value			1 bit	C	R	W	T	-	switch	Low
42	Value send, Channel E	1-bit Value			1 bit	C	R	W	T	-	switch	Low
43	Value send, Long, Channel E	1-bit Value			1 bit	C	R	W	T	-	switch	Low
51	Value send, Channel F	1-bit Value			1 bit	C	R	W	T	-	switch	Low
52	Value send, Long, Channel F	1-bit Value			1 bit	C	R	W	T	-	switch	Low
60	Value send, Channel G	1-bit Value			1 bit	C	R	W	T	-	switch	Low
61	Value send, Long, Channel G	1-bit Value			1 bit	C	R	W	T	-	switch	Low
69	Value send, Channel H	1-bit Value			1 bit	C	R	W	T	-	switch	Low
70	Value send, Long, Channel H	1-bit Value			1 bit	C	R	W	T	-	switch	Low

Figure 6.2.7

Number	Name	Data type	Attribute
6,15,24,33,42,51,60,69	Value send,Channel X	1 bit	C,R,W,T

In Channel X (X=A~H), when "Value send" is selected for the parameter "Function mode" and "Yes" is selected for the

parameter "Value for sending", this communication object is used to send channel on/off telegrams to the bus to control on/off.			
7,16,25,34,43,52,61,70	Value send. Lona. Channel X	1 bit	C,R,W,T
In Channel X (X=A~H), when "Value send" is selected for the parameter "Function mode" and "Yes" is selected for the parameter "Value for sending", this communication object is used to send channel on/off telegrams to the bus to control on/off.			

表 1.7

6.2.8 Feedback object function

There are 8 objects in the feedback-object control LED indicator function, as shown in Figure 6.2.8, the specific functions are shown in Table 1.8

Number	Name *	Object Function	Description	Group Address	Length	C	R	W	T	U	Data Type	Priority
8	Status feedback, Channel A	On / Off			1 bit	C	-	W	T	U	switch	Low
17	Status feedback, Channel B	On / Off			1 bit	C	-	W	T	U	switch	Low
26	Status feedback, Channel C	On / Off			1 bit	C	-	W	T	U	switch	Low
35	Status feedback, Channel D	On / Off			1 bit	C	-	W	T	U	switch	Low
44	Status feedback, Channel E	On / Off			1 bit	C	-	W	T	U	switch	Low
53	Status feedback, Channel F	On / Off			1 bit	C	-	W	T	U	switch	Low
62	Status feedback, Channel G	On / Off			1 bit	C	-	W	T	U	switch	Low
71	Status feedback, Channel H	On / Off			1 bit	C	-	W	T	U	switch	Low

Figure 6.2.8

Number	Name	Data type	Attribute
8,17,26,35,44,53,62,71	Status feedback, Channel X	1 Bit	C,R,W,T
This communication object is enabled when the parameter "triggering of status LED" selects "ON when feedback object=1; OFF when 0" or "OFF when feedback object=1; ON when 0" or "flashes when feedback object=1; OFF when 0" or "OFF when feedback object=1; flashes when 0" , object is used to bind the feedback object and use the received feedback status to control the status of the LED indicator.			

Table 1.8

6.2.9 Status light brightness function

There is one object through the object rewriting status light function, as shown in Figure 6.2.9, the specific function is shown in Table 1.9

Number	Name *	Object Function	Description	Group Address	Length	C	R	W	T	U	Data Type	Priority
72	Overwrite brightness, Statu...	8-bit Value			1 byte	C	R	W	T	-	percentage (0..100%)	Low

Figure 6.2.9

Number	Name	Data type	Attribute
72	Overwrite brightness, Status LED	1byte	C,R,W,T
This communication object is enabled when the parameter "Overwrite brightness via object for all channel" is set to "Yes". This object is used to rewrite the status light brightness.			

Table 1.9

6.2.10 Backlight brightness function

There is one object through the object rewriting backlight brightness function, as shown in Figure 6.2.10, the specific function is shown in Table 1.10(This parameter not available yet.)

Number	Name	Object Function	Description	Group Address	Length	C	R	W	T	U	Data Type	Priority
74	Overwrite brightness, Waki...	8-bit Value			1 byte	C	R	W	T	-	percentage (0..100%)	Low
75	Overwrite brightness, Sleep...	8-bit Value			1 byte	C	R	W	T	-	percentage (0..100%)	Low
76	Input-triggering, Waking B...	1-bit Value			1 bit	C	R	W	T	-	switch	Low
77	Triggering output, Waking...	1-bit Value			1 bit	C	R	W	T	-	switch	Low
78	Master output, Control oth...	On / Off			1 bit	C	R	W	T	-	switch	Low
79	Input from master, Control...	On / Off			1 bit	C	R	W	T	-	switch	Low

Figure 6.2.10

Number	Name	Data type	Attribute
73	Overwrite brightness, Backlight	1byte	C,R,W,T
This communication object is enabled when the parameter "Overwrite backlight brightness via object" is set to "Yes". This object is used to rewrite the backlight brightness.			
74	Overwrite brightness, Waking backlight	1byte	C,R,W,T
This communication object is enabled when the parameter "Overwrite waking backlight via object" is set to "Yes". This object is used to rewrite the brightness of the backlight that is awakened.			
75	Overwrite brightness, Sleeping backlight	1byte	C,R,W,T
This communication object is enabled when the parameter "Overwrite waking backlight via object" is set to "Yes". This object is used to overwrite the backlight brightness during sleep (after the delay expires)			
76	Input-triggering, waking backlight	1bit	C,R,W,T
This communication object is enabled when the parameter "Waking up backlight via object" selects "Yes". This object is used to wake up the backlight function.			
77	Triggering output, Waking Backlight	1bit	C,R,W,T
This communication object is enabled when the parameter "Output-triggering single for waking backlight" selects "Yes". This object is used to output the start signal to wake up the backlight function.			
78	Master output, Control other' s backlight	1bit	C,R,W,T
This communication object is enabled when the parameter "Master output for controlling other' s backlight" selects "Yes" . This object is used to control the backlight function of the slave panel.			
79	Input from master, Control own backlight	1bit	C,R,W,T
This communication object is enabled when the parameter "Delay time after waking backlight" selects "delay according to master device". This object is used to switch the backlight function of the slave panel according to the switch signal sent from the master device.			

Table 1.10

6.2.11 Device lock function

The control device lock function has 2 objects, as shown in Figure 6.2.11, the specific function is shown in Table 1.11

Number	Name	Object Function	Description	Group Address	Length	C	R	W	T	U	Data Type	Priority
80	Input, Device lock control	Unlocking / Lock...			1 bit	C	R	W	T	-	switch	Low
81	Output, Status for device lo...	Unlocking / Lock...			1 bit	C	R	-	T	-	switch	Low

图 6.2.11

Number	Name	Data type	Attribute
80	Input, Device lock control	1bit	C,R,W,T
This communication object is enabled when "Device lock" or "Device lock and other program mode" is selected in the parameter "Select in other function", this object is used to disable the operation function of the keys, if this function is enabled, the operation function of the panel keys will be invalidated.			

81	Output, Status for device lock	1bit	C,R,T
This communication object is enabled when "Device lock" is selected for the parameter "Select in other function" and "Yes" is selected for the parameter "Send status of lock on changes", and is used to send changes in the status of the key lock.			

7 Safe use and maintenance

- (1) Read all instructions carefully before use.
- (2) Create a good ventilation environment.
- (3) During use, pay attention to moisture, shock and dust.
- (4) Strictly forbid to rain, contact with other liquids or corrosive gases.
- (5) If it is wet or attacked by liquid, it should be dried in time.
- (6) When the machine fails, please contact professional maintenance personnel or our company.

8 Contact

Address: 9th Floor, Building 5, Aotelang Science and Technology Park, No. 68, Nanxiang 1st Road, Huangpu District, Guangzhou City, Guangdong Province, China

Tel: +86-20-82189121

Fax: +86-20-82189121

Website: <http://www.seawin-knx.com>