

INTERRA

CERTIFIED R&D CENTER OF AUTOMATION

Developer of Uniqueness

6 CHANNEL 10 A BALLAST DIMMING MODULE

Product Manual



Information contained in this publication regarding device applications and the like is provided only for your convenience and may be superseded versions by updates. It is your responsibility to ensure that your application meets with your specifications.

INTERRA MAKES NO REPRESENTATIONS OR WARRANTIES OF ANY KIND WHETHER EXPRESS OR IMPLIED, WRITTEN OR ORAL, STATUTORY OR NONSTATUTORY, RELATED TO THE INFORMATION INCLUDING BUT NOT LIMITED TO ITS CONDITION, QUALITY, PERFORMANCE, MERCHANTABILITY OR FITNESS FOR PURPOSE.

Interra disclaims all liability arising from this information and its use. Use of Interra devices in life support and / or safety applications is entirely at the buyer's risk, and the buyer agrees to defend, indemnify and hold harmless Interra from any and all damages, claims, suits, or expenses resulting from such use. No licenses are conveyed, implicitly or otherwise under any Interra intellectual rights.

Trademarks

The Interra name and logo and the Interra ITR500-0001 6 Channel 10 A Ballast Dimming Module are registered trademarks of Interra Technology in Turkey and other countries.

All other trademarks mentioned herein are property of the Interra Technology.

© 2021, Interra, Printed in Turkey, All Rights Reserved.



Printed on recycled paper.

TS EN ISO 9001:2008

TO OUR CUSTOMERS

One of our most important aims is to provide you with the best documentation possible to use successfully your Interra products. Focusing of this, we will keep on improving our documentation to better suit your needs. Our publications will be updated as new volumes as soon as changes are introduced.

If you have any questions or comments regarding this publication, do not hesitate to contact us:

E-mail: info@interra.com.tr

Tel: +90 (216) 326 26 40 Fax: +90 (216) 324 25 03

Most Current Product Manual

To obtain the most up-to-date version of this product manual, please visit our Web site at:

<http://www.interra.com.tr>

You can determine the version of an Interra document examining its literature number found on the bottom right corner of any page.

The first two letters of the literature are the type of document. The numbers that follow are the creation date of the document and the last letter is the version (e.g., PM181017001A is the version A of a product manual created on the date 17/10/18.)

CONTENTS

1.) PRODUCT DESCRIPTION.....	6
1.1.) TECHNICAL INFORMATION	7
1.2.) PRODUCT FUNCTIONS.....	8
1.3.) PRODUCT DIMENSIONS	9
1.4.) CONNECTION DIAGRAM AND PROGRAMMING.....	9
2.) MOUNTING.....	10
3.1. GENERAL PARAMETER PAGE.....	10
3.1.1. Parameters List	11
3.2. G:SEQUENCE 1-5.....	11
3.2.1. Parameters List	12
3.3. CHANNEL A-F.....	13
3.3.1. Parameters List	13
3.4. DIMMING	15
3.4.1. Parameters List	15
3.5. FUNCTION.....	17
3.5.1. Parameters List	17
3.6. STAIRCASE LIGHT FUNCTION.....	18
3.6.1. Parameters List	18
3.7. FLASHING FUNCTION	19
3.7.1. Parameters List	20
3.8. SCENE FUNCTION.....	21
3.8.1. Parameters List	21
3.9. THRESHOLD FUNCTION.....	22
3.9.1. Parameters List	22
3.10. LOGIC FUNCTION	24
3.10.1. Parameters List	24
3.11. HEATING FUNCTION	25
3.11.1. Parameters List	25
4.1. GENERAL	27
4.2. OUTPUT N	27
4.3. RESPONSE STATE	28
4.4. STATISTIC ON TIME.....	28
4.5. STAIRCASE LIGHT	28
4.6. FLASH.....	28

4.7. SCENE	29
4.8. THRESHOLD	29
4.9. LOGIC	29
4.10. HEATING	29

1.) PRODUCT DESCRIPTION

ITR500-0001 – 6 Channel 10A Ballast Dimming Module, can dimming from 0V to 10V for per channel. Database uploads to the product are done with most current ETS version. The device is manufactured in accordance with electromagnetic compatibility (EMC), electrical safety and environmental conditions. ITR500-0001 device's outputs for max 10A be switched ON or OFF on every output channel, also can manually switched. Control types include both input and output, so absorption and output type ballast can be connected to this module.

1.1.) TECHNICAL INFORMATION

Product Code	ITR500-0001
Power Supply	EIB Power Supply
Current Consumption	5 mA (static) 15 mA (dynamic)
Dimming Output	24 mA @ 0 – 10 V DC per channel
Channel Current	10 A @ 220-250 V AC (50/60 Hz)
Maximum Air Humidity	<90 RH
Temperature Range	Operation (– 5°C ...45 °C) Storage (– 20°C ...60 °C)
Flammability	Non-flammable Product
Type of Protection	IP 20
Dimensions	90 x 144 x 66 mm (HxWxD)
Color	Light Grey and White
Configuration	Configuration with ETS
Certificaton	KNX Certified

1.2.) PRODUCT FUNCTIONS

- 6 Channel 0-10 V dimming and maximum 10 A relay output for every channel.
- Also can manually switch.
- The switch functions : Statistical total ON time, status response, status recovery, upper limit, lower limit, staircase light, scene control, scene dimming, sequence control, threshold switch, heating actuator(PWM).

1.3.) PRODUCT DIMENSIONS

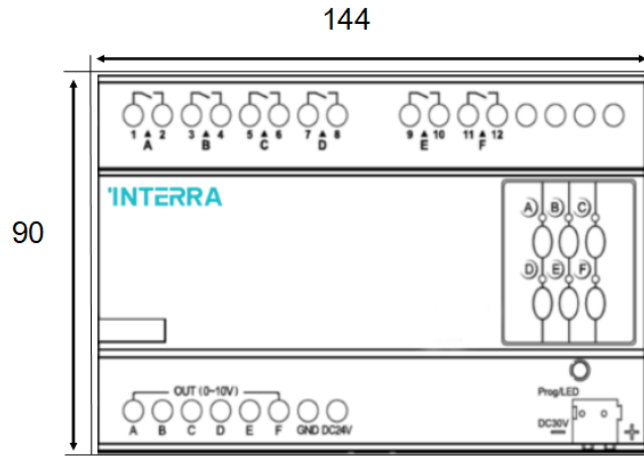

Fig 1 : Front Appearance and Measures of the Device.

The numerical values showing the dimensions above are in mm.

1.4.) CONNECTION DIAGRAM AND PROGRAMMING

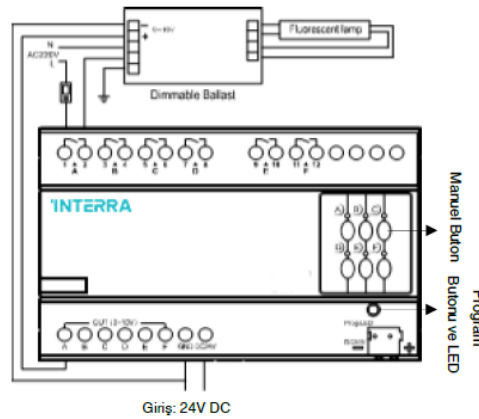

Fig 2 : KNX Connector(+ -), Programming LED and Button.

Connection to the device is via the KNX connector, AC and load wires. Once the connections have been made correctly, the device can now be programmed. The programming button is pressed first, then the programming LED is illuminated after pressing. In this way, the ETS configuration can be loaded to the device.

2.) MOUNTING

ITR500-0001 - 6 Channel 10 A Ballast Dimming Module during mounting; AC cables, load cables and KNX / EIB cables must be labeled and completely isolated from each other. The device must be installed on a DIN rail in the distribution board and cables must be connected for loads. After making sure that there is no short or open circuit, check that the KNX cable type is correct and not short-circuited. After this process, the KNX cables must be connected with the correct color and all cables must be properly assembled. After the processes are finished, ensure that the KNX line is isolated from the AC line.

3. ETS PARAMETERS AND DESCRIPTIONS

3.1. GENERAL PARAMETER PAGE

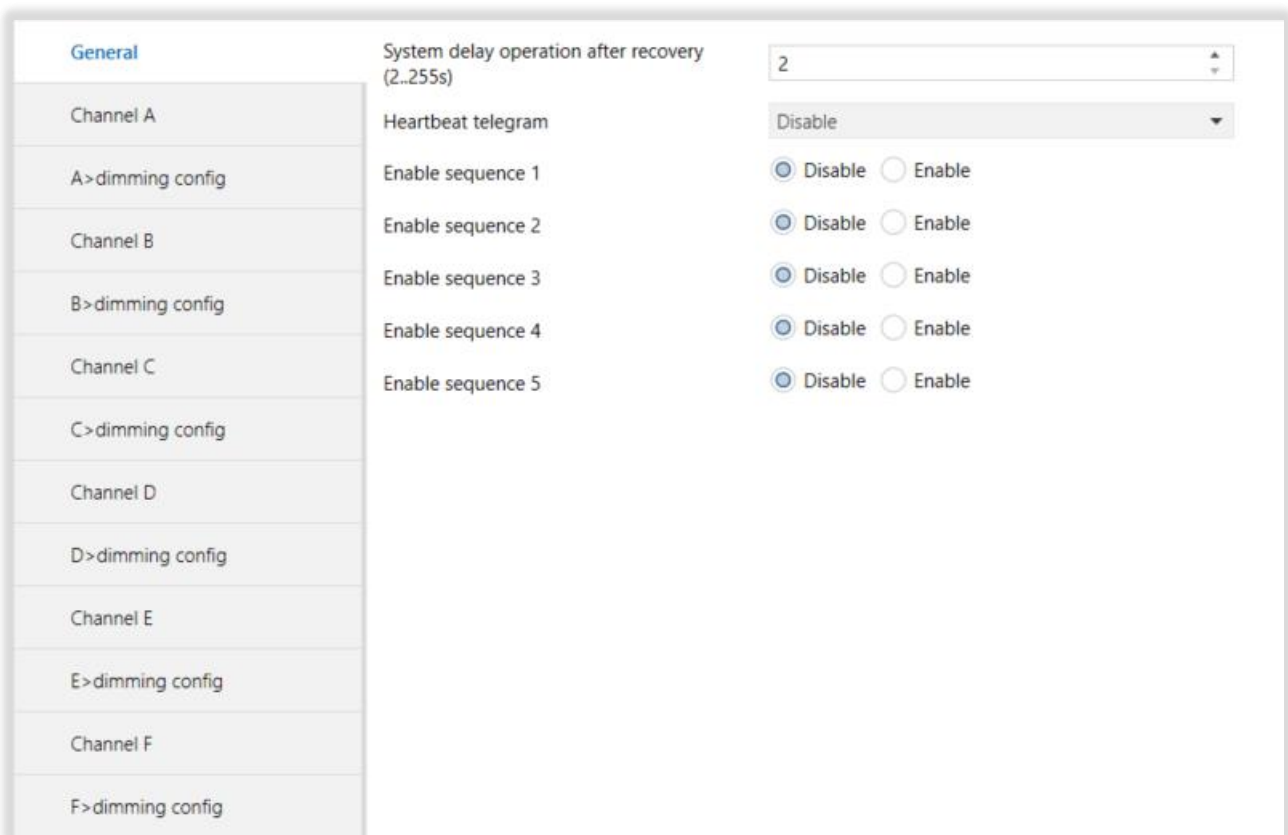

Fig 3 : General Parameter Configuration Page

3.1.1. Parameters List

PARAMETERS	DESCRIPTION	VALUES
System delay(2..255s) after recovery	This parameter, is used for set the delay time for the device after power on.	2..255
Heartbeat telegram	This parameter, is used to send cyclically heartbeat telegrams. If the value is 0, the device will send 0 cyclically. Also, if the value is 1/0, the device will send alternately 0 and 1 value cyclically.	Disable Send value 0 cyclically Send value 1 cyclically Send value 1/0 inverted cyclically
Telegram is sent time interval (1..65535s)*¹	This parameter, allows sending the telegram cyclically after time out.	1..5..65535s
Enable sequence 1 ... Enable sequence 5	This parameter, is used to enable or disable sequences 1-5.	Disable Enable

3.2. G:SEQUENCE 1-5

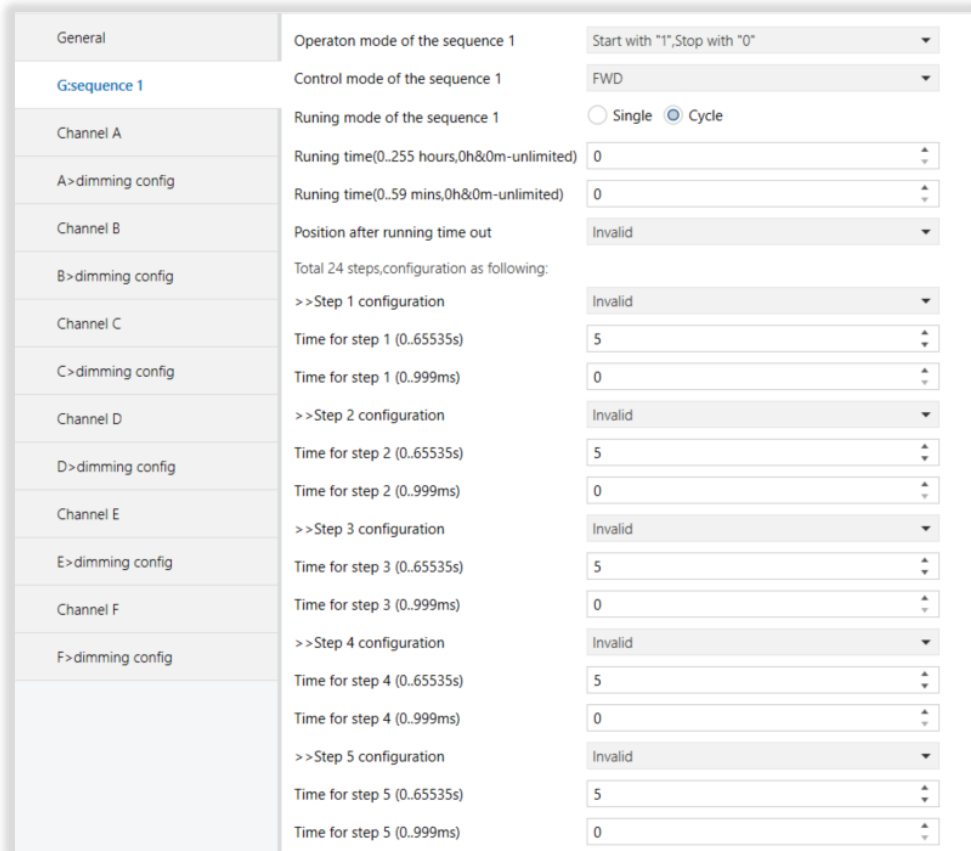

Fig 4 : G:Sequence Parameter Page

3.2.1. Parameters List

PARAMETERS	DESCRIPTION	VALUES
Operation mode of the sequence 1	<p>This parameter, is used to set the operation mode for sequence 1.</p> <p>Start with “1”, Stop with “0” : If a telegram is received with a value of ‘1’, sequence 1 will start. If a telegram is received with value of ‘0’, sequence 1 will stop.</p> <p>Start with “0”, Stop with “1” : If a telegram is received with a value of ‘0’, sequence 1 will start. If a telegram is received with value of ‘1’, sequence 1 will stop.</p> <p>Start with “1/0”, Can’t stop : If a telegram is received with a value of ‘0’ or ‘1’, sequence 1 will start and not stop.</p>	<p>Start with “1”, Stop with “0”</p> <p>Start with “0”, Stop with “1”</p> <p>Start with “1/0”, Can’t stop</p>
Control mode of the sequence 1	<p>This parameter, is used to set the control mode for sequence 1.</p> <p>FWD : Forward mode.</p> <p>REW : Backward mode.</p> <p>RANDOM : Random mode.</p>	<p>FWD</p> <p>REW</p> <p>RANDOM</p>
Running mode of the sequence 1	<p>This parameter, is used to set the running mode for sequence 1.</p> <p>Single : Will run once.</p> <p>Cycle : Will run cyclically.</p>	<p>Single</p> <p>Cycle</p>
Running time (0...255 hours, 0h&0m-unlimited)	<p>This parameter, is used to set the running time in hours.</p>	<p>0...255</p>
Running time (0...59 mins, 0h&0m-unlimited)	<p>This parameter, is used to set the running time in minutes.</p>	<p>0...59</p>
Position after running time out	<p>This parameter, is used to set the scene to be activated when time out occurs.</p>	<p>Invalid</p> <p>Scene NO.01..Scene NO.64</p>
<p>>>Step 1 configuration</p> <p>...</p> <p>Step 24 configuration</p>	<p>This parameter, is used to set the scene for step 1...24.</p>	<p>Invalid</p> <p>Scene NO.01..Scene NO.64</p>
<p>Time for step 1</p> <p>...</p> <p>Time for step 24</p>	<p>This parameter, is used to set the time for step 1...24 is seconds.</p>	<p>0...5...65535s</p>
<p>Time for step 1</p> <p>...</p>	<p>This parameter, is used to set the time for step 1...24 in milliseconds.</p>	<p>0...999ms</p>

Time for step 24		
------------------	--	--

3.3. CHANNEL A-F

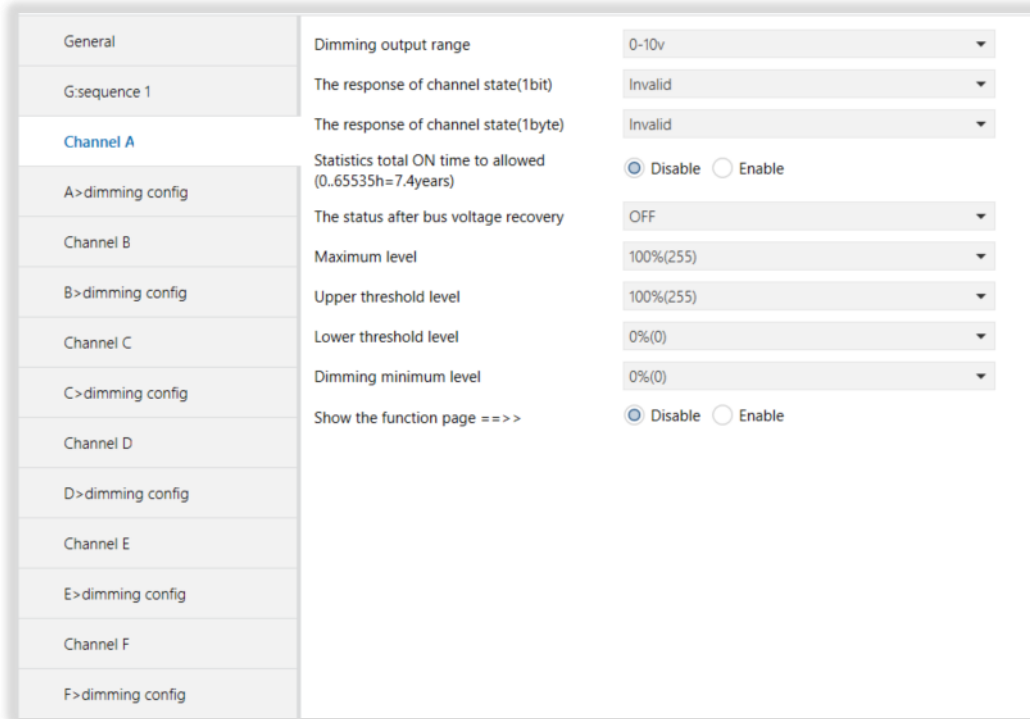

Fig 5 : Channel A-F Parameter Page

3.3.1. Parameters List

PARAMETERS	DESCRIPTION	VALUES
Dimming output range	This parameter, is used to set the dimming output.	0-10V 1-10V 2-10V
The response of channel state (1 bit)	This parameter, is used to set the channel state response parameters(1 bit). 1 bit always response : The channel will always respond, if on it will respond with 1, if off it will respond with 0. 1 bit only changed : The channel will respond only when the dimmer state has changed.	Invalid 1 bit always response 1 bit only changed
The response of channel (1 byte)	This parameter, is used to set the channel state response parameters(1 byte). 1 byte always response : The channel will always respond. 1 byte only changed : The channel will respond when the light value has changed.	Invalid 1 byte always response 1 byte only changed

Statistics total ON time to allowed (0...65535h=7.4 years)	This parameter, is used to enable or disable statistics function.	Disable Enable
Alarm when time out (1...65535h, 0-invalid)	This parameter, is used to set the alarm timeout parameters.	1... 30000 ...65535h 0-invalid
Transmit telegram interval when alarm(1...255s)	This parameter, is used to set the alarm time interval.	1... 10 ...255s
The status after bus voltage recovery	This parameter, is used to set the status after bus voltage. OFF : After powered on, the channel will be OFF. Defined brightness value : After powered on, the channels status will be defined by the brightness value. Last brightnes value : After powered on, the channels status will be defined by the last brightness value.	OFF Defined brightness value Last brightness value
Brightness value	This parameter, is used to set the brightness value parameters.	0% ...100%
Maximum level	This parameter, is used to set the maximum level.	0... 100%
Upper threshold level	This parameter, is used to set the upper threshold level.	0... 100%
Lower threshold level	This parameter, is used to set the lower threshold level.	0 ...100%
Dimming minimum level	This parameter, is used to set the minimum dimming level.	0 ...100%
Show the function page==>>	This parameter, is used to enable or disable the function page.	Enable Disable

3.4. DIMMING

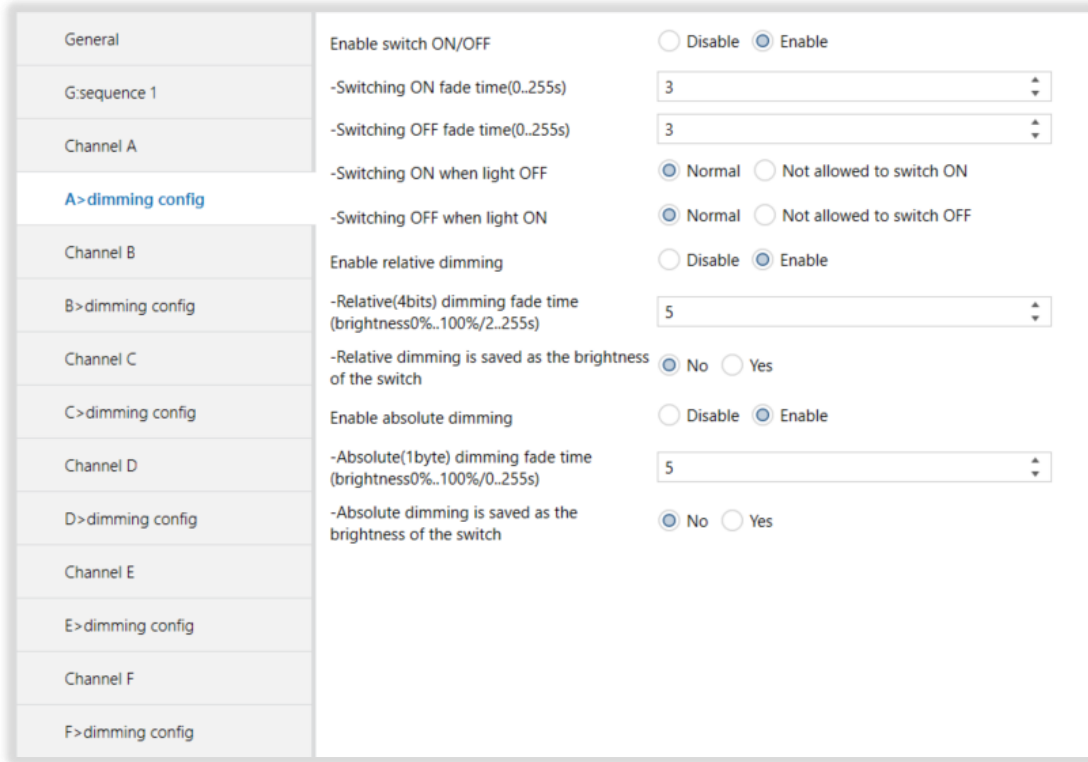

Fig 6 : Dimming Parameter Page

3.4.1. Parameters List

PARAMETERS	DESCRIPTION	VALUES
Enable switch ON/OFF	This parameter, is used to enable or disable the ON/OFF switch.	Disable Enable
-Switching ON fade time (0...255s)	This parameter, is used to set the switch ON fade time.	0...3...255s
-Switching OFF fade time (0...255s)	This parameter, is used to set the switch OFF fade time.	0...3...255s
-Switching ON when light OFF	This parameter, is used to set the parameter for switching ON when the light is OFF. Normal : When the status is normal, the function can be used. Not allowed to switch ON : When the status is not allowed to switch ON, the function can not be used.	Normal Not allowed to switch ON

<p>-Switching OFF when light ON</p>	<p>This parameter, is used to set the parameter for switching OFF when the light is ON.</p> <p>Normal : When the status is normal, the function can be used.</p> <p>Not allowed to switch OFF : When the status is not allowed to switch OFF, the function can not be used.</p>	<p>Normal</p> <p>Not allowed to switch OFF</p>
<p>Enable relative dimming</p>	<p>This parameter, is used to enable or disable the relative dimming.</p> <p>Disable : Disallows relative dimming.</p> <p>Enable : Allows relative dimming.</p>	<p>Disable</p> <p>Enable</p>
<p>-Relative (4 bits) dimming fade time (brightness 0%...100%/2...255s)</p>	<p>This parameter, is used to set the fade time for relative dimming.</p>	<p>2...5...255s</p>
<p>-Relative dimming is saved as the brightness of the switch</p>	<p>This parameter, is used to enable or disable the relative dimming</p>	<p>No</p> <p>Yes</p>
<p>Enable absolute dimming</p>	<p>This parameter, is used to enable or disable absolute dimming.</p>	<p>Disable</p> <p>Enable</p>
<p>-Absolute (1 byte) dimming fade time (brightness0%...100% /0..255s)</p>	<p>This parameter, is used to set the fade time for absolute(1 byte) dimming.</p>	<p>0...5...255s</p>
<p>-Absolute dimming is saved as the brightness of the switch</p>	<p>This parameter, is used to enable or disable the absolute dimming saved brightness.</p>	<p>No</p> <p>Yes</p>

3.5. FUNCTION

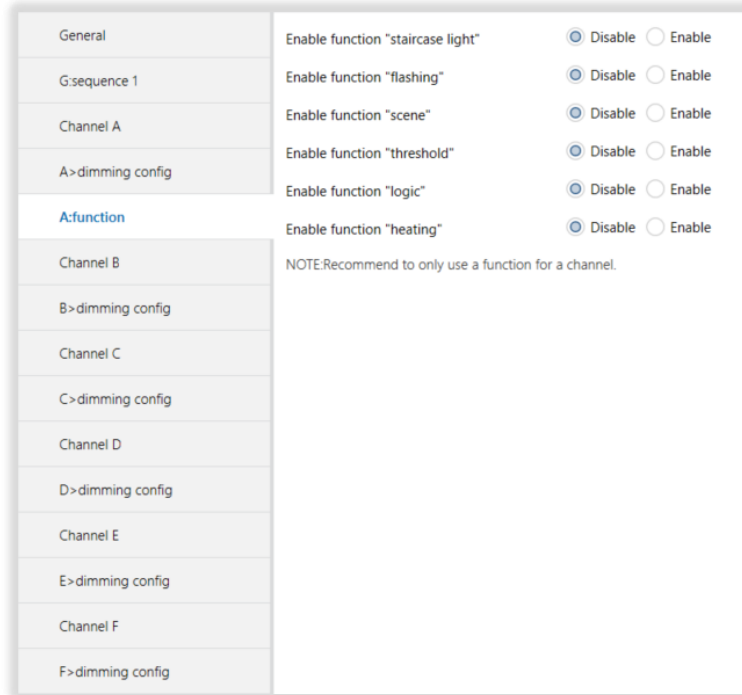

Fig 7 : Function Parameter Page

3.5.1. Parameters List

PARAMETERS	DESCRIPTION	VALUES
Enable function “staircase light”	This parameter, is used to enable or disable the “staircase light” function.	Disable Enable
Enable function “flashing”	This parameter, is used to enable or disable the “flashing” function.	Disable Enable
Enable function “scene”	This parameter, is used to enable or disable the “scene” function.	Disable Enable
Enable function “threshold”	This parameter, is used to enable or disable the “threshold” function.	Disable Enable
Enable function “logic”	This parameter, is used to enable or disable the “logic” function.	Disable Enable
Enable function “heating”	This parameter, is used to enable or disable the “heating” function.	Disable Enable

3.6. STAIRCASE LIGHT FUNCTION

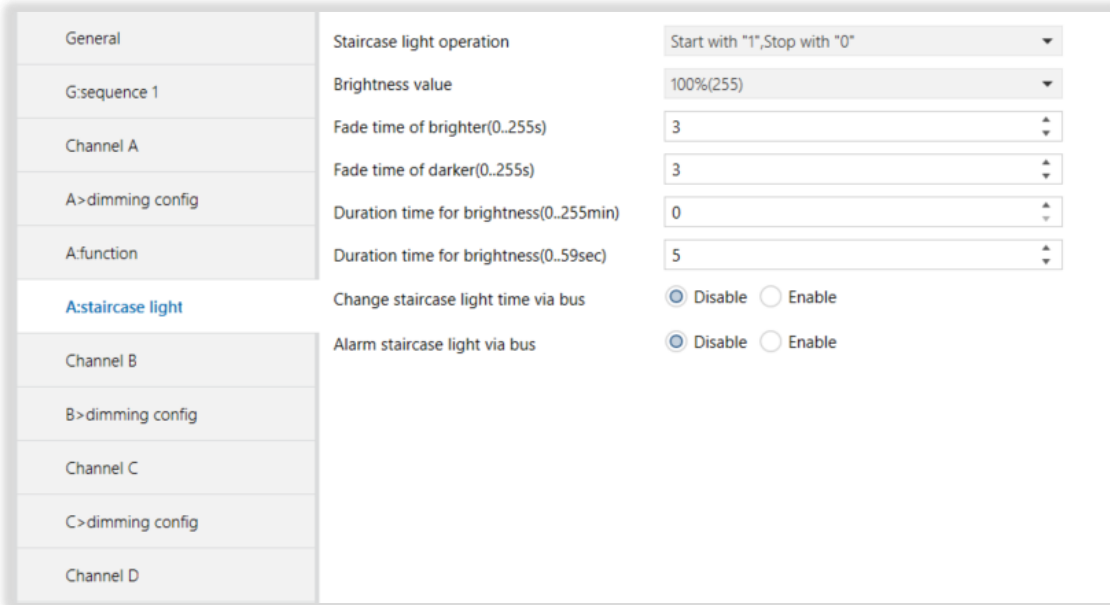

Fig 9 : Staircase Light Function Parameter Page

3.6.1. Parameters List

PARAMETERS	DESCRIPTION	VALUES
Staircase light operation	<p>This parameter, is used to set the parameters for staircase lighting operation.</p> <p>Start with “1”, Stop with “0” : If telegram “1” is received, the staircase lighting will activate, if telegram “0” is received the staircase lighting will deactivate.</p> <p>Start with “1”, Invalid with “0” : If telegram “1” is received, the staircase lighting will activate, if telegram “0” is received the staircase function will be invalid.</p> <p>Start with “1/0”, Can’t stop : If telegram “1/0” is received, the staircase lighting will remain constantly active.</p>	<p>Start with “1”, Stop with “0”</p> <p>Start with “1”, Invalid with “0”</p> <p>Start with “1/0”, Can’t stop</p>
Brightness value	This parameter, is used to set the light intensity.	0...100%
Fade time of brighter(0...255s)	This parameter, is used to set the rate at which the lighting intensity increases.	0...3...255s
Fade time of darker(0...255s)	This parameter, is used to set the rate at which the lighting intensity decreases.	0...3...255s

Duration time for brightness (0...255min)	This parameter, is used to set the time to attain maximum brightness.	0...255s
Duration time for brightness (0...59sec)	This parameter, is used to set the time to attain maximum brightness.	0...5...59
Change staircase light time via bus	<p>This parameter, is used to enable or disable staircase lighting times.</p> <p>Enable : Allows the staircase lighting time to be modified.</p> <p>Disable : Does not allow the staircase lighting time to be modified. If this is set the lighting can only be set via the database.</p>	<p>Disable</p> <p>Enable</p>
Alarm staircase light via bus	<p>This parameter, is used to enable or disable the staircase warning light via the bus.</p> <p>Enable : Allows an alarm to be triggered.</p> <p>Disable : Does not allow an alarm to be triggered.</p>	<p>Disable</p> <p>Enable</p>

3.7. FLASHING FUNCTION

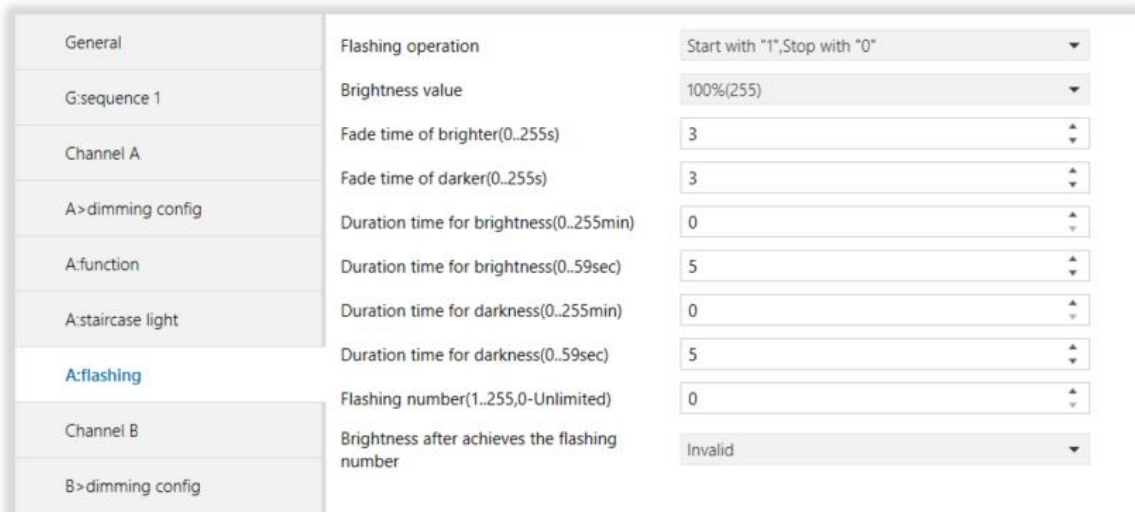

Fig 10 : Flashing Function Parameter Page

3.7.1. Parameters List

PARAMETERS	DESCRIPTION	VALUES
Flashing operation	<p>This parameter, is used to set the parameters for flashing operation.</p> <p>Start with “1”, Stop with “0” : If telegram “1” is received, flashing function will be activated, if telegram “0” is received flashing function will be deactivated.</p> <p>Start with “0”, Stop with “1” : If telegram “0” is received, flashing function will be activated, if telegram “1” is received flashing function will be deactivated.</p> <p>Start with “1/0”, Can’t stop : If telegram “1/0” is received, the flashing function will remain constantly active.</p>	<p>Start with “1”, Stop with “0”</p> <p>Start with “0”, Stop with “1”</p> <p>Start with “1/0”, Can’t stop</p>
Brightness value	This parameter, is used to set the brightness value.	0...100%
Fade time of brighter(0...255s)	This parameter, is used to set the rate at which the lighting intensity increases.	0...3...255s
Fade time of darker(0...255s)	This parameter, is used to set the rate at which the lighting intensity decreases.	0...3...255s
Duration time for brightness (0...255min)	This parameter, is used to set the brightness duration time in minutes.	0...255min
Duration time for brightness (0...59sec)	This parameter, is used to set the brightness duration time in seconds.	0...5...59sec
Duration time for darkness (0...255min)	This parameter, is used to set the darkness duration time in minutes.	0...255min
Duration time for darkness (0...59sec)	This parameter, is used to set the darkness duration time in seconds.	0...5...59sec
Flashing number(1...255, 0-Unlimited)	This parameter, is used to set the number of flashes.	<p>0-unlimited</p> <p>1...255</p>
Brightness after achieves the flashing number	This parameter, is used to set the brightness parameters for after a set number of flashes has been activated.	<p>Invalid</p> <p>0...100%</p>

3.8. SCENE FUNCTION

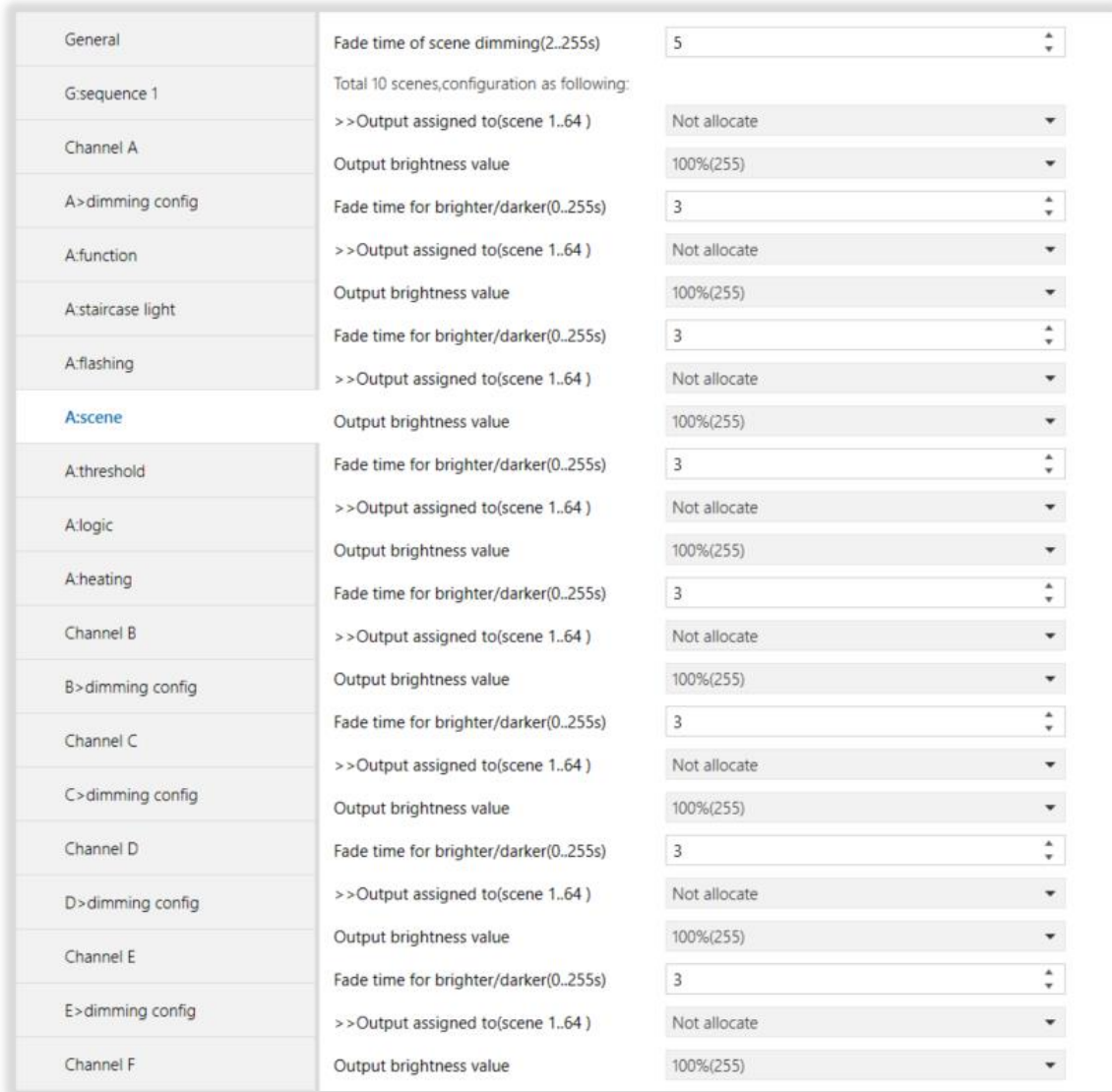

Fig 10 : Scene Function Parameter Page

3.8.1. Parameters List

PARAMETERS	DESCRIPTION	VALUES
Fade time of scene dimming (2...255s)	This parameter, is used to set the fade time for scene dimming.	2...5...255s
Total 10 scenes, configuration as following:		
>> Output assigned to(scene 1...64)	This parameter, is used to set the output scene.	Not allocate Scene No 1...Scene No.64

Output brightness value	This parameter, is used to set the output brightness value.	0...100%
Fade time for brighter/darker (0...255s)	This parameter, is used to set the brightening and dimming fading rate.	0...3...255s

3.9. THRESHOLD FUNCTION

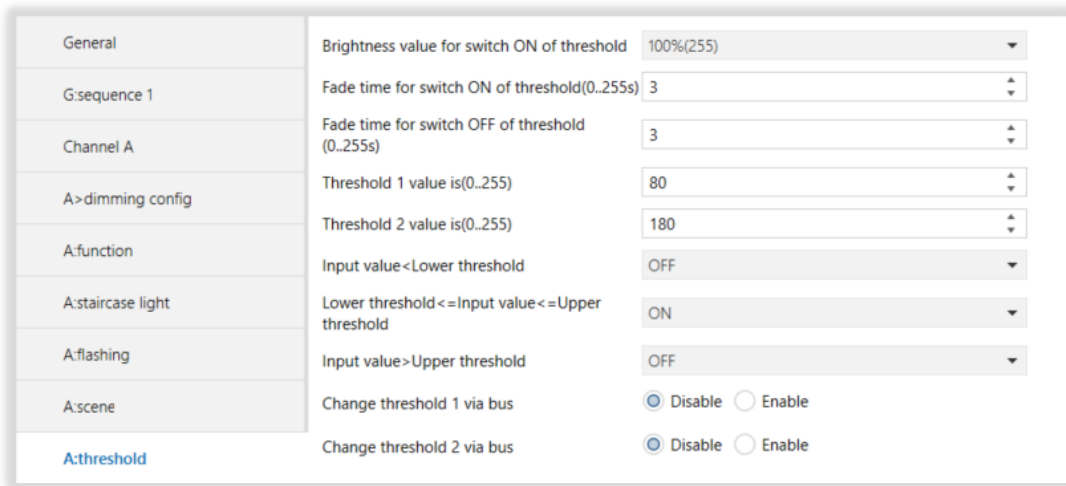

Fig 11 : Threshold Function Parameter Page

3.9.1. Parameters List

PARAMETERS	DESCRIPTION	VALUES
Brightness value for switch ON of threshold	This parameter, is used to set the brightness value when switched on.	0...100%(255)
Fade time for switch ON of threshold(0...255s)	This parameter, is used to set the switch on fade time.	0...3...255s
Fade time for switch OFF of threshold(0...255s)	This parameter, is used to set the switch off fade time.	0...3...255s
Threshold 1 value is (0...255)	This parameter, is used to set the value for threshold 1.	0...80...255
Threshold 2 value is (0...255)	This parameter, is used to set the value for threshold 2.	0...180...255

<p>Input value <=Lower threshold</p>	<p>This parameter, is used to set the <=Lower threshold input value status.</p> <p>Unchanged : The switch position will not change.</p> <p>ON: The switch position is set to ON.</p> <p>OFF: The switch position is set to OFF.</p>	<p>Unchanged ON OFF</p>
<p>Lower threshold <= Input value <= Upper threshold</p>	<p>This parameter, is used to set the lower threshold <= input value <= upper threshold.</p> <p>Unchanged : The switch position will not change.</p> <p>ON: The switch position is set to ON.</p> <p>OFF: The switch position is set to OFF.</p>	<p>Unchanged OFF ON</p>
<p>Input value >Upper threshold</p>	<p>This parameter, is used to set the input upper threshold value status.</p> <p>Unchanged : The switch position will not change.</p> <p>ON: The switch position is set to ON.</p> <p>OFF: The switch position is set to OFF.</p>	<p>Unchanged ON OFF</p>
<p>Change threshold 1 via bus</p>	<p>This parameter, is used to enable or disable the threshold 1 function.</p> <p>Enable : The value of threshold 1 can be changed from the bus.</p> <p>Disable : The value of threshold 1 can not be changed from the bus.</p>	<p>0...59</p>
<p>Change threshold 2 via bus</p>	<p>This parameter, is used to enable or disable the threshold 2 function.</p> <p>Enable : The value of threshold 2 can be changed from the bus.</p> <p>Disable : The value of threshold 2 can not be changed from the bus.</p>	<p>0...10...59</p>

3.10. LOGIC FUNCTION

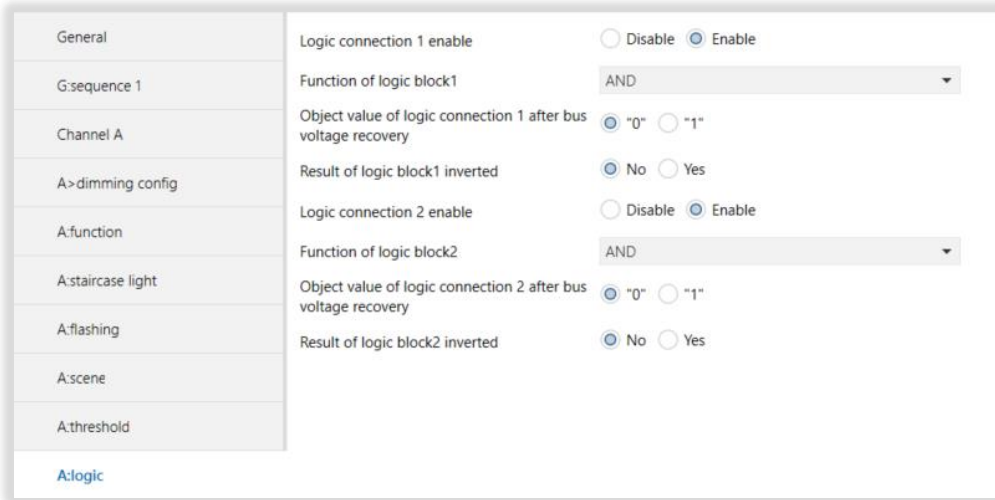

Fig 12 : Logic Function Parameter Page

3.10.1. Parameters List

PARAMETERS	DESCRIPTION	VALUES
Logic connection 1 enable	This parameter, is used to enable or disable logic connection 1.	Enable Disable
-Function of logic block 1	This parameter, is used to set the logic block 1 functions. AND : Boolean calculation is according to “AND”. OR : Boolean calculation is according to “OR”. XOR : Boolean calculation is according to “XOR”. GATE : When the condition 1 is set to ‘1’, the channel will pass through logic block 1 to logic block 2.	AND OR XOR GATE
Object value of logic connection 1 after bus voltage recovery	This parameter, is used to send the logic 1 connection parameters after bus voltage recovery.	‘0’ ‘1’
Result logic of block 1 inverted	This parameter, is used to enable or disable the inversion of results from logic block 1.	No Yes
Logic connection 2 enable	This parameter, is used to enable or disable logic connection 2.	Disable Enable

-Function of logic block 2	This parameter, is used to set the logic block 2 functions. AND : Boolean calculation is according to “AND”. OR : Boolean calculation is according to “OR”. XOR : Boolean calculation is according to “XOR”. GATE : When the condition 1 is set to ‘1’, the channel will pass through logic block 2.	AND OR XOR GATE
-Object value of logic connection 2 after bus voltage recovery	This parameter, is used to send the logic 2 connection parameters after bus voltage recovery.	‘0’ ‘1’
Result logic of block 2 inverted	This parameter, is used to enable or disable the inversion of result from logic block 2.	No Yes

3.11. HEATING FUNCTION

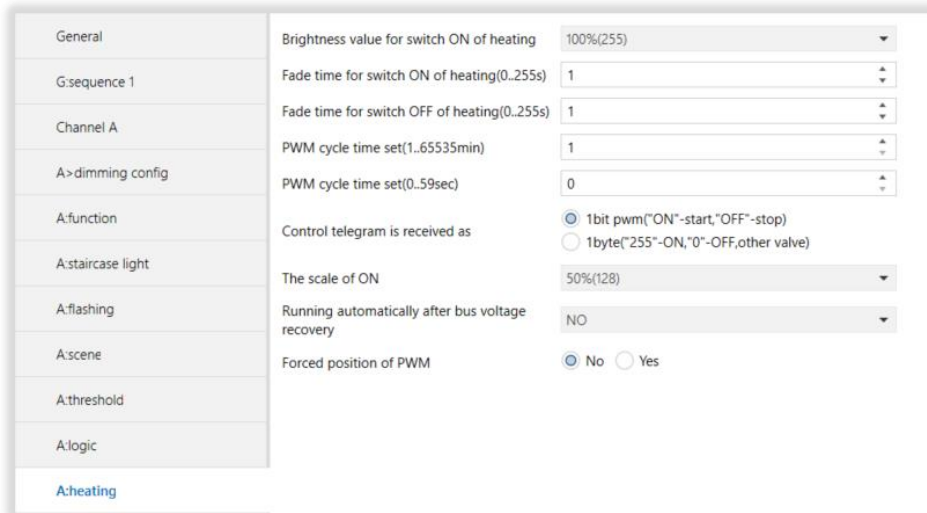

Fig 13 : Heating Function Parameter Page

3.11.1. Parameters List

PARAMETERS	DESCRIPTION	VALUES
Brightness value for switch ON of heating	This parameter, is used to set the brightness value for when heating is switched on.	0...100%
Fade time for switch ON of heating (0...255s)	This parameter, is used to set the rate at which the heating intensity increases when switched ON.	0...1...255
Fade time for switch OFF of heating(0...255s)	This parameter, is used to set the rate at which the heating intensity decreases when switched OFF.	0...1...255

PWM cycle time set (1...65535min)	This parameter, is used to set the PWM cycle time.	1...65535min
PWM cycle time set (1...59sec)	This parameter, is used to set the PWM cycle time.	0...59sec
Control telegram is received as	This parameter, is used to set the control type. 1 bit pwm("ON"-start, "OFF"-stop) : If telegram "1" is received, the PWM will start, if telegram "0" is received, the PWM will stop. 1 byte("255"-ON, "0"-OFF, other value) : If telegram "255" is received, the PWM will switch ON. If telegram "0" is received, the PWM will stop and the PWM status will be set according to the other value(1...254).	1 bit pwm("ON"-start, "OFF"-stop) 1 byte("255"-ON, "0"-OFF, other value)
The scale of ON	This parameter, is used to set the value for scale of ON.	1...50...100%
Running automatically after bus voltage recovery	This parameter, is used to set the PWM parameters. NO : The PWM will run a customised value. Defined Value : The PWM will run a defined value. Recovery : The PWM will run automatically.	NO Defined value Recovery
-Position of the valve	This parameter, is used to set the value for position of the valve.	0...50...100%
Forced position of PWM	This parameter, is used to enable or disable the forced PWM position.	Yes No
-Valve of PWM	This parameter, is used to set the value for valve of PWM.	0...50...100%

4. ETS OBJECTS AND DESCRIPTIONS

There are several parameters and functions with the same feature when making the relevant configurations from the parameter pages. The objects of the same properties are the same, and only the names of the objects are different. Hence, in this section, 1 of the objects with the same feature is explained.

4.1. GENERAL

At the following table, the objects associated with the general parameter page are described.

Object Name	Function	Type	Flags
General	Heartbeat telegram	1 bit	C T
This object, when set '0', will send the telegram value '0' cyclically, when set '1', will send the telegram value '1' cyclically; when set '0/1', will send the telegram value '0/1' cyclically.			
General	Sequence1	1 bit	C W U
This object, is used to enable or disable the sequence1. If telegram "0" is sent the sequence 1 will be disabled, if telegram "1" is sent the sequence will be enabled.			
General	Sequence2	1 bit	C W U
This object, is used to enable or disable the sequence2. If telegram "0" is sent the sequence 1 will be disabled, if telegram "1" is sent the sequence will be enabled.			
General	Sequence3	1 bit	C W U
This object, is used to enable or disable the sequence3. If telegram "0" is sent the sequence 1 will be disabled, if telegram "1" is sent the sequence will be enabled.			
General	Sequence4	1 bit	C W U
This object, is used to enable or disable the sequence4. If telegram "0" is sent the sequence 1 will be disabled, if telegram "1" is sent the sequence will be enabled.			
General	Sequence5	1 bit	C W U
This object, is used to enable or disable the sequence5. If telegram "0" is sent the sequence 1 will be disabled, if telegram "1" is sent the sequence will be enabled.			

4.2. OUTPUT N

At the following table, the objects associated with the output n are described.

Object Name	Function	Type	Flags
Output A	Channel output	1 bit	C W U
This object, is used to set the channel output with control ON/OFF.			
Output A	Relative dimming(4 bit)	4 bit	C W U
This object, is used for relative dimming. When the "increase" telegram is received, the value will be increased. When the "decrease" telegram is received, the value will be decreased.			

Output A	Absolute dimming (8 bit)	1 Byte	C W U
----------	--------------------------	--------	-------

This object, is used for absolute dimming. When the absolute dimming telegram is received, the lights will be dimmed according to the telegrams value.

4.3. RESPONSE STATE

At the following table, the objects associated with the response state are described.

Object Name	Function	Type	Flags
Output A	Response state (1 bit)	1 bit	C R T

This object, is used for response the state, when response state is “1”, the channel is ON. If the response state is “0”, the channel is OFF.

Output A	Response state (1 byte)	1 Byte	C R T
----------	-------------------------	--------	-------

This object, is used for the response state of the output channel brightness.

4.4. STATISTIC ON TIME

At the following table, the objects associated with the statistic on time are described.

Object Name	Function	Type	Flags
Output A	R/W total ON time	2 Byte	C R W T U

This object, is used if the initial value is changed. The statistical ON time will increase again every hour.

Output A	Alarm when total ON time out	1 bit	C R T
----------	------------------------------	-------	-------

This object, is used to trigger an alarm, when statistical ON time has reached the maximum set value.

4.5. STAIRCASE LIGHT

At the following table, the objects associated with the staircase light are described.

Object Name	Function	Type	Flags
Output A	Staircase light	1 bit	C W U

This object, is used for staircase lighting. If telegram “1” is received, the staircase lighting will be activated. If telegram “0” is received, the staircase lighting will be deactivated.

Output A	Change staircase light time	2 Byte	C W U
----------	-----------------------------	--------	-------

This object, is used to change the staircase lighting illumination time.

Output A	Alarm case light	1 bit	C R T
----------	------------------	-------	-------

This object is used to set the alarm status lighting.

4.6. FLASH

At the following table, the object associated with the flash are described.

Object Name	Function	Type	Flags
Output A	Flashing	1 bit	C W U

This object, is used for flashing function. When the start value is received, the lighting channel will flash.

4.7. SCENE

At the following table, the objects associated with the scene are described.

Object Name	Function	Type	Flags
Output A	Scene(8 bit)	1 byte	C W U

This object, is used to call or save the channel output scene.

Output A	Scene dimming(4 bit)	4 bit	C W U
----------	----------------------	-------	-------

This object, is used for scene dimming.

4.8. THRESHOLD

At the following table, the objects associated with the threshold are described.

Object Name	Function	Type	Flags
Output A	Threshold input	1 Byte	C W U

This object, is used for threshold input. The input value is compared with threshold 1 and threshold 2.

Output A	Change threshold 1	1 Byte	C W U
----------	--------------------	--------	-------

This object, is used to change threshold 1 via the bus network.

Output A	Change threshold 2	1 Byte	C W U
----------	--------------------	--------	-------

This object, is used to change threshold 2 via the bus network.

4.9. LOGIC

At the following table, the objects associated with the logic are described.

Object Name	Function	Type	Flags
Output A	Logic connection 1	1 bit	C W U

This object, is used to set the logic state 1.

Output A	Logic connection 2	1 bit	C W U
----------	--------------------	-------	-------

This object, is used to set the logic state 2.

4.10. HEATING

At the following table, the objects associated with the heating are described.

Object Name	Function	Type	Flags
Output A	Heat with 1 bit control	1 bit	C W U
<p>This object, is used for the heating actuator, if telegram “1” is received the PWM will start. If telegram “0” is received the PWM will stop.</p>			
Output A	Heat with 1 byte control	1 byte	C W U
<p>This object, is used to modify the PWM value by receiving 1 byte data. If telegram “255” is received, the output will be on. If telegram “0” is received, the output will be OFF.</p>			

CONTACT INFORMATION

THE INTERRA WEB SITE

Interra provides documentation support via our web site www.interra.com.tr. This web site is used as a means to make files and information easily available to customers. Accessible by using your favorite Internet browser, the web site contains the following information:

- Information about our products and projects.
- Overview of Interra company and values.
- Product Support: Data sheets, product manuals, application descriptions, latest software releases, ETS databases and archived software.

Europe, Turkey

Interra

Cumhuriyet Mah. Kartal Cad. No:95/1

Simkan Plaza 34876 Kartal/İstanbul

Tel: +90 (216) 326 26 40 Fax: +90 (216) 324 25 03

Web address: <http://www.interra.com.tr/>