

INTERRA

— Developer of Uniqueness —

LG Air Condition Units AC - KNX Gateway Product Manual

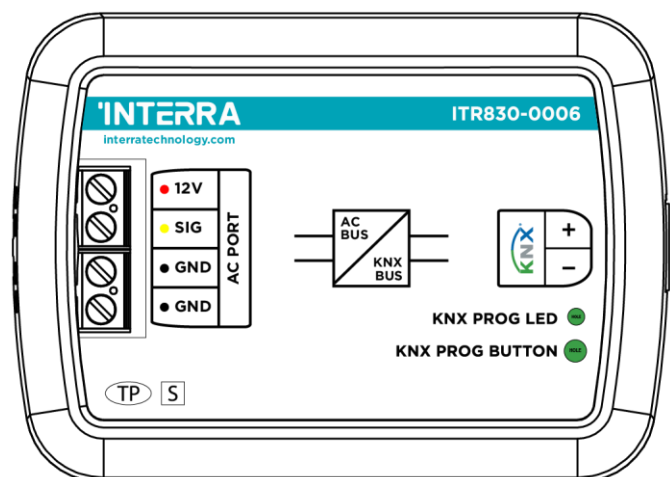

Contents

- 1. Content of The Document** 5
- 2. Product Description** 6
 - 2.1. Technical Information..... 7
 - 2.2. Connection Diagram & Features..... 8
 - 2.3 Dimensions 11
- 3. ETS Parameters & Descriptions** 12
 - 3.1. General Page 13
 - 3.1.1. Parameters List 14
 - 3.2. Logic Gate 17
 - 3.2.1. Parameters List 19
 - 3.3. Converter 21
 - 3.3.1. Parameters List 23
 - 3.4. Operating Mode 26
 - 3.4.1. Parameters List 31
 - 3.5. Fan..... 37
 - 3.5.1. Parameters List 41
 - 3.6. Vanes..... 43
 - 3.6.1. Parameters List 45
 - 3.7. Temperature 48
 - 3.7.1. Parameters List 50
 - 3.8. Scenes..... 52
 - 3.8.1. Parameters List 54
 - 3.9. Special 56
 - 3.9.1. Parameters List 58
- 4. ETS Objects List & Descriptions** 61
 - 4.1. General Objects 62
 - 4.2. Logic Gate Objects 64
 - 4.3. Converter Objects 65
 - 4.4. Operating Mode Objects..... 66
 - 4.5. Fan Group Objects..... 71
 - 4.6. Vanes Group Objects..... 73
 - 4.7. Temperature Group Objects 75
 - 4.8. Scene Group Objects 76
 - 4.9. Special Group Objects 77
- Appendix** 79

Information contained in this publication regarding device applications and the like is provided only for your convenience and may be superseded versions by updates. It is your responsibility to ensure that your application meets your specifications.

INTERRA MAKES NO REPRESENTATIONS OR WARRANTIES OF ANY KIND WHETHER EXPRESS OR IMPLIED, WRITTEN OR ORAL, STATUTORY OR NONSTATUTORY, RELATED TO THE INFORMATION INCLUDING BUT NOT LIMITED TO ITS CONDITION, QUALITY, PERFORMANCE, MERCHANTABILITY OR FITNESS FOR PURPOSE.

Interra disclaims all liability arising from this information and its use. Use of Interra devices in life support and/or safety applications is entirely at the buyer's risk, and the buyer agrees to defend, indemnify and hold harmless Interra from any damages, claims, suits, or expenses resulting from such use. No licenses are conveyed, implicitly or otherwise under any Interra intellectual rights.

Trademarks

The Interra name and logo and the Interra ITR830-0006 LG AC – KNX Gateway devices are registered trademarks of Interra Technology in Turkey and other countries.

All other trademarks mentioned herein are property of Interra Technology.

© 2022, Interra, Printed in Turkey, All Rights Reserved.



Printed on recycled paper.

TS EN ISO 9001:2008

TO OUR CUSTOMERS

One of our most important aims is to provide you with the best documentation possible to use successfully your Interra products. Focusing on this, we will keep on improving our documentation to better suit your needs. Our publications will be updated as new volumes as soon as changes are introduced.

If you have any questions or comments regarding this publication, do not hesitate to contact us:

E-mail: info@interra.com.tr

Tel: +90 (216) 326 26 40 Fax: +90 (216) 324 25 03

Most Current Product Manual

To obtain the most up-to-date version of this product manual, please visit our Web site at:

<http://www.interratechnology.com>

You can determine the version of an Interra document by examining its literature number found on the bottom right corner of any page.

The first two letters of the literature are the type of document. The numbers that follow are the creation date of the document and the last letter is the version (e.g., PM181017001A is the version A of a product manual created on the date 17/10/18).

1. Content of The Document

This document contains Interra brandmark's ITR830-0006 LG AC - KNX Gateway coded devices' electronic and all essential feature information for programming these products. In each subtitle is explained the characteristics of the device. Modifications of the product and special change requests are only allowed in coordination with product management.

2. Product Description

ITR830-0006 is an air conditioner gateway used for monitoring and controlling all the functioning parameters of LG air conditioners via the KNX bus line. LG AC - KNX Gateway is compatible with models in VRV types categorized in the compatibility list sold by LG.

LG AC - KNX Gateway has an easy installation feature and can be installed inside the own AC indoor unit or a proper location away from the air conditioner, it connects one side directly to the electronic circuit of the AC indoor unit and in the other side directly to the KNX bus so, LG Gateway provides bidirectional communication between KNX and AC bus.

- 12V/SIG/GND bus connections can be made up to 50 meters away. The bus terminal connects the AC indoor unit and the wired remote controller.
- Up to 5 different modes are available to determine the operating mode such as; auto, heat, cool, fan, dry.
- ITR830-0006 have 4 logic gates to carry out logic functions with 3 different gate types such as AND, OR & XOR.
- With 4 different special modes, desired applications can be made. These modes are: Energy Saver mode, Power Saver mode, Winter mode and summer mode.
- ITR830-0006 have 8 converter gates with 1 input and 1 output. Each input has 8 different data types and each output has 4 different outputs.
- Up to 5 scenes can be saved and executed from KNX, fixing the desired combination of ON/OFF, Operation Mode, Setpoint Temperature, Fan Level control, Vane Position control and Remote Controller Lock at any moment by using a simple switching with KNX bus telegram.
- LG type AC Indoor unit can be controlled simultaneously by the remote controller of the AC unit and LG Gateway.
- LG indoor unit monitoring from KNX, including monitoring of AC unit's state of internal variables, running working hours counter (E.g., for filter maintenance control), and error indication and error code.
- Control of the AC unit based on the ambient temperature read by the own AC unit, or in the ambient temperature read by any KNX thermostat.
- Special functions for high-level monitoring; window contact, working hours counter, standby and timer function.

2.1. Technical Information

The following table shows the technical information of the LG Gateway.

Product Code	ITR830-0006
Power Supply	KNX Power Supply
Power Consumption	10 mA
Push Buttons	1 x KNX Programming Button
LED Indicators	1 x KNX Programming LED
Type of Protection	IP 20
Cable Distance	Max 50 m
Mode of Commissioning	S-Mode
Temperature Range	Operation (0°C...40°C)
	Storage (-10°C...70°C)
Maximum Air Humidity	< 90 RH
Colour	Light Grey
Dimensions	88 x 62 x 27 mm (W x H x D)
Certification	KNX Certified
Configuration	Configuration with ETS

2.2. Connection Diagram & Features

Once the device is provided with a power supply from the KNX bus, both the physical address and the associated application program can be downloaded.

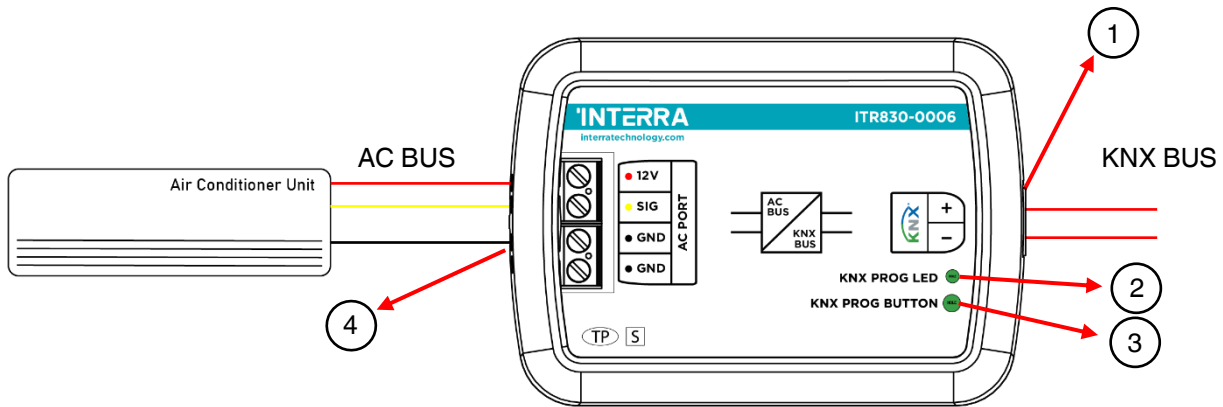

Fig. 1 : Connection Diagram of LG AC - KNX Gateway

Number	Feature
1	KNX Connector
2	Programming LED
3	Programming Button
4	AC Indoor Unit Connection

Recommended



The interface should be installed inside the air conditioning indoor unit. Due to the connection length up to 50 meters, LG Gateway can also be installed at the proper location outside the air conditioner.

ITR830-0006 LG AC - KNX Gateway can be connected directly to the 12V-SIG-GND Home bus terminal of the AC indoor unit. Nothing that needs to do in ETS software. The following figure shows the LG Gateway connection without the remote controller.

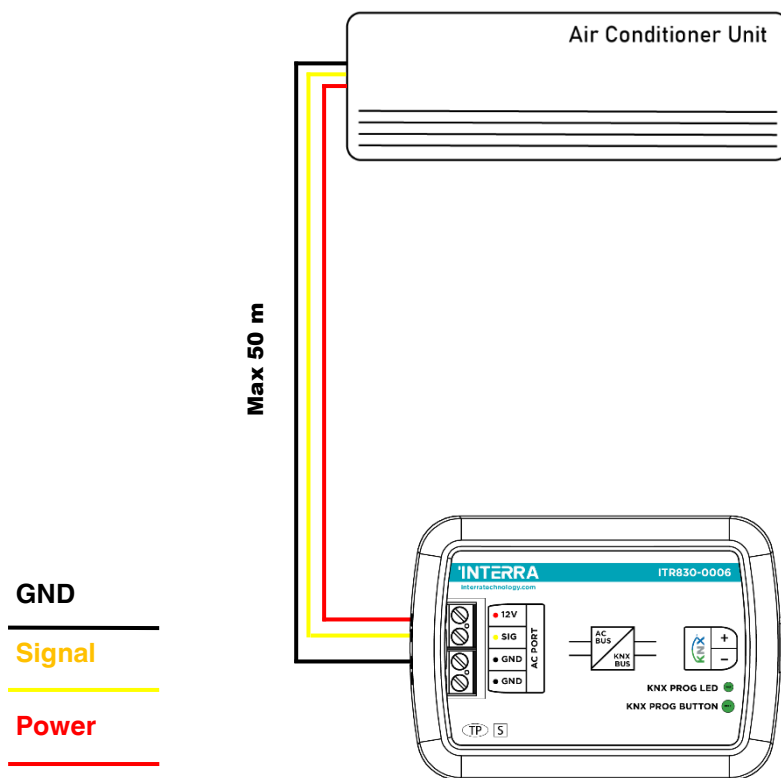

Fig. 2 : LG Gateway Connection Diagram without LG Remote Controller

LG AC - KNX Gateway can be connected with LG Remote Controller to the 12V-SIG-GND Home bus terminal of the AC indoor unit. In this case, the remote control unit must be selected as Master in the LG Gateway ETS configuration. The following figure shows the LG Gateway connection with the remote controller.

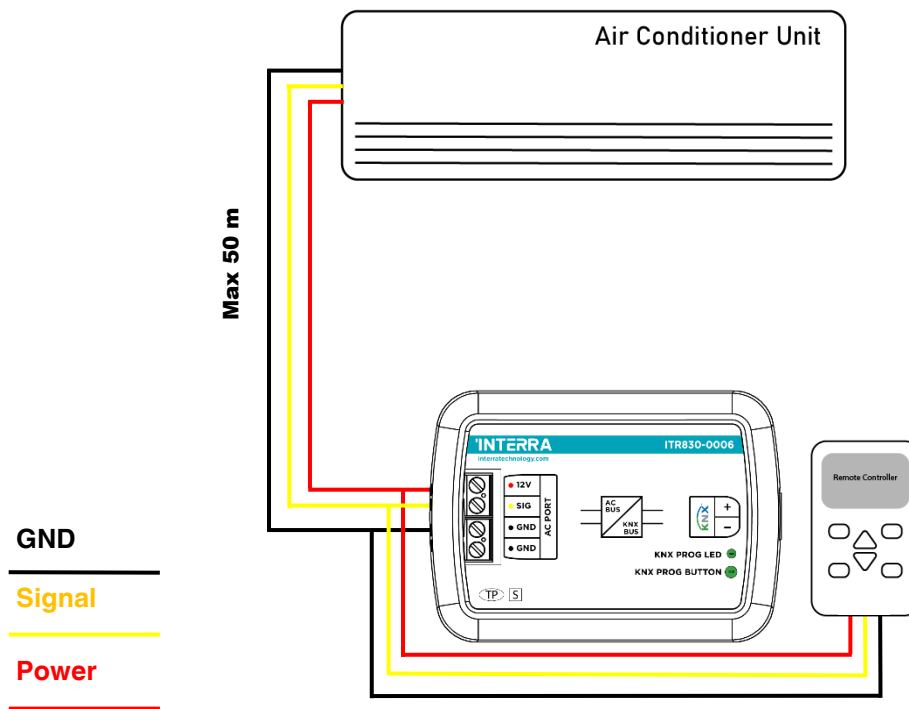

Fig. 3 : LG Gateway Connection Diagram with LG Remote Controller

Commissioning Instructions



- > First, disconnect the Air Conditioner from mains power.
- > Then, disconnect the power supply of the EIB bus.
- > Install the interface and connect it to the 12V-SIG-GND bus at any point of the bus. The 12V-SIG-GND bus is the bus that connects the AC indoor unit and the wired remote controller
- > Connect the KNX bus to the KNX connector of the interface according to polarity.
- > Reconnect the AC indoor unit to mains power and power supply to the KNX bus.

2.3 Dimensions

All values given in the device dimensions are millimetres.

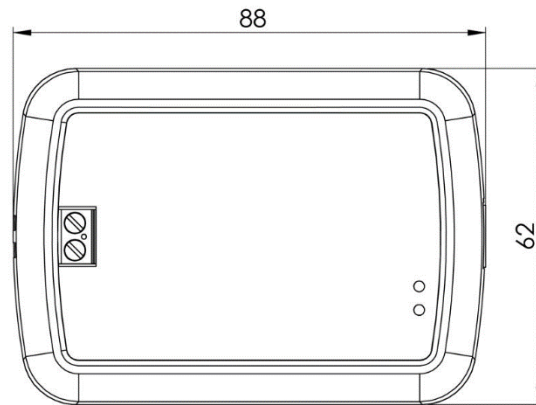

Fig. 4 : Dimensions of LG AC - KNX Gateway from the top view

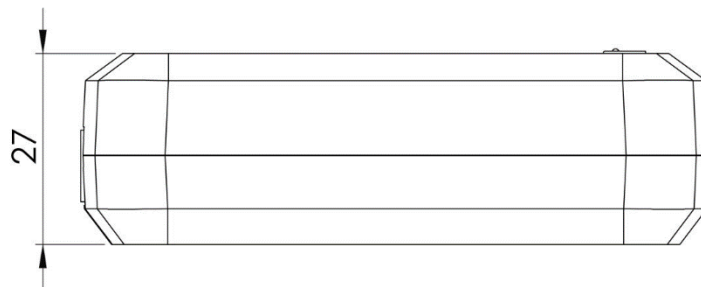

Fig. 5 : Dimensions of LG AC - KNX Gateway from the side view

3. ETS Parameters & Descriptions

In this chapter, the ETS parameters of the ITR830-0006 LG AC - KNX Gateway device are described using the parameter pages and options. The parameter pages features are dynamic structures which mean further parameters and parameter pages are enabled depending on the configuration and function of the groups.

In this section, a detailed description of the functional features of the device is given. All the parameters of the device are explained under the relevant headings.

In the ETS parameter configuration pages, each of the parameters has got a default parameter value. These default values are written in bold.

- E.g. : > Setpoint shifting •**via parameter** via communication object

Special Notes



This is a fully compatible KNX device that must be configured and setup using the standard KNX tool ETS.

In the following sections, there is a detailed explanation about each of the different functionalities of LG AC - KNX Gateway in ETS.

3.1. General Page

When the LG Gateway is attached to the project from the ETS program, a configuration setting must be made primarily before loading. When entering the “GENERAL” in the parameter page, the configuration screen will be appeared shown below. Global parameter settings for the whole device are made in this window. From the general configuration window, the different advanced functionalities of the LG Gateway can be enabled such as Module alive beacon, Setting the working condition of the remote controller, Behaviours after bus voltage failure, Device control locking, Errors Management, Initial Configuration.

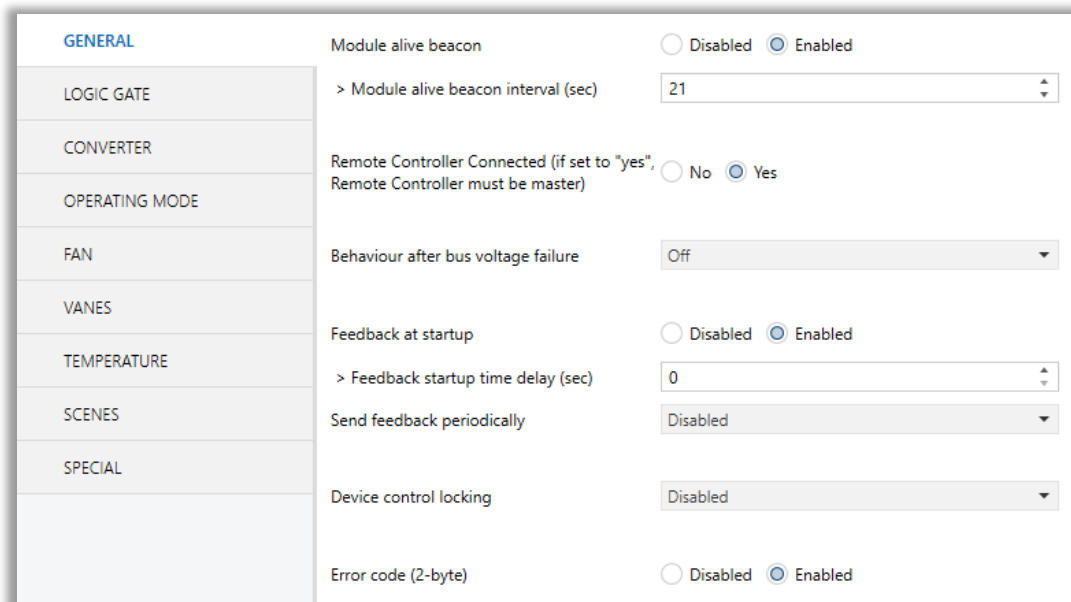



Fig. 6 : General Configuration Parameter Page

3.1.1. Parameters List

PARAMETERS	DESCRIPTION	VALUES
Module alive beacon	This feature is used to determine whether the LG Gateway is operating. With the enabling of the module alive beacon parameter whether the device is working correctly can be known. The value true is sent with a preconfigured period via the group object. The receipt of this telegram periodically means that the device is working properly.	Disabled Enabled
> Module alive beacon interval(sec)	This parameter is used to determine the time of the module alive beacon sending data.  Where the KNX bus line communication is intensive, it is more accurate to select the bigger time. Otherwise, even communication breaks may occur.	1...65535
Remote Controller Connected (if set to “yes”, Remote Controller must be master)	This parameter is used to determine whether the LG Gateway and the air conditioner remote controller are used together. If the remote control is to be used, the controller must be selected as the master.	No Yes
Behaviour after bus voltage failure	This parameter is used to determine the action that will be taken by the gateway when the KNX bus voltage failure is recovered. If there is a power interruption or until the KNX energy comes back up, one of the following options can be applied. No Reaction/Last State: The air conditioner unit retains its last condition after the power failure. On: The air conditioner will be switched on. Off: The air conditioner will be switched off. Scene: The scene with the desired conditions from 5 different scenes can be sent to the air conditioner unit. In this case, the air conditioner unit operates under these conditions after KNX bus line power failure.	No reaction – Last state Scene On Off
> Scene selection	This parameter is used to determine the appropriate scene from the 5 scenes that can be created. The selected scene conditions are	Scene 1, Scene 2, Scene 3, Scene 4, Scene 5

	applied to the air conditioner and it works under these conditions after the KNX bus power failure.	
Feedback at start-up	<p>This parameter is used to get some status information of the air conditioning unit when the LG Gateway is started to operate.</p> <p>This information can be used for these purposes such as : monitoring the air conditioner from a control centre, triggering different scenarios to operate in the KNX infrastructure etc. The following describes which status information can be observed.</p> <p>Feedback Climate On/Off</p> <p>Feedback Operating Mode</p> <p>Feedback Individual Mode Auto & Heat & Cool & Fan & Dry</p> <p>Feedback Fan Speed Enumerated</p> <p>Feedback Vanes Position Enumerated</p> <p>Feedback Setpoint Temperature</p>	<p>Disabled</p> <p>Enabled</p>
> Feedback at start-up time delay(sec)	<p>This parameter is used to set the delay between the start-up and the sending of the feedback telegrams to the KNX bus line.</p> <p> If the value is selected as '0', the feedbacks will be sent to the KNX bus line immediately without no waiting.</p>	0...255
Send feedback periodically	<p>This parameter is used to send feedback on the related objects periodically according to the selected time.</p> <p>The objects are listed in the "Feedback at start-up" parameter that is described above.</p>	<p>Disabled</p> <p>5sec, 10sec, 30sec, 1min, 5min, 10min, 20min, 30min, 40min, 50min, 1h, 2h, 3h, 4h, 5h, 6h, 12h, 24h</p>
Device Control Locking	<p>This parameter is used to lock the LG Gateway via device control locking communication object. The device is blocked and it can no longer be controlled via any telegram. The device remains the previous status before locking until the locking is deactivated. It must be taken into consideration that the device after the locking will take the last</p>	<p>Disabled</p> <p>Lock on Value 0</p> <p>Lock on Value 1</p>

	<p>value received through the bus even though this value has been received during the locking time.</p> <p>Lock on Value 0: The Gateway will be locked when the value 0 is sent.</p> <p>Lock on Value 1: The Gateway will be locked when value 1 is sent.</p>	
<p>Error code (2-byte)</p>	<p>This parameter is used to detect and identify the faults that come from the air conditioner via a 2-byte value. Each error code has a different meaning so, all of the error code descriptions are listed please check the Appendix B section in this document.</p>	<p>Disabled</p> <p>Enabled</p>

3.2. Logic Gate

This parameter page is used to make the logical relationships between inputs & output.

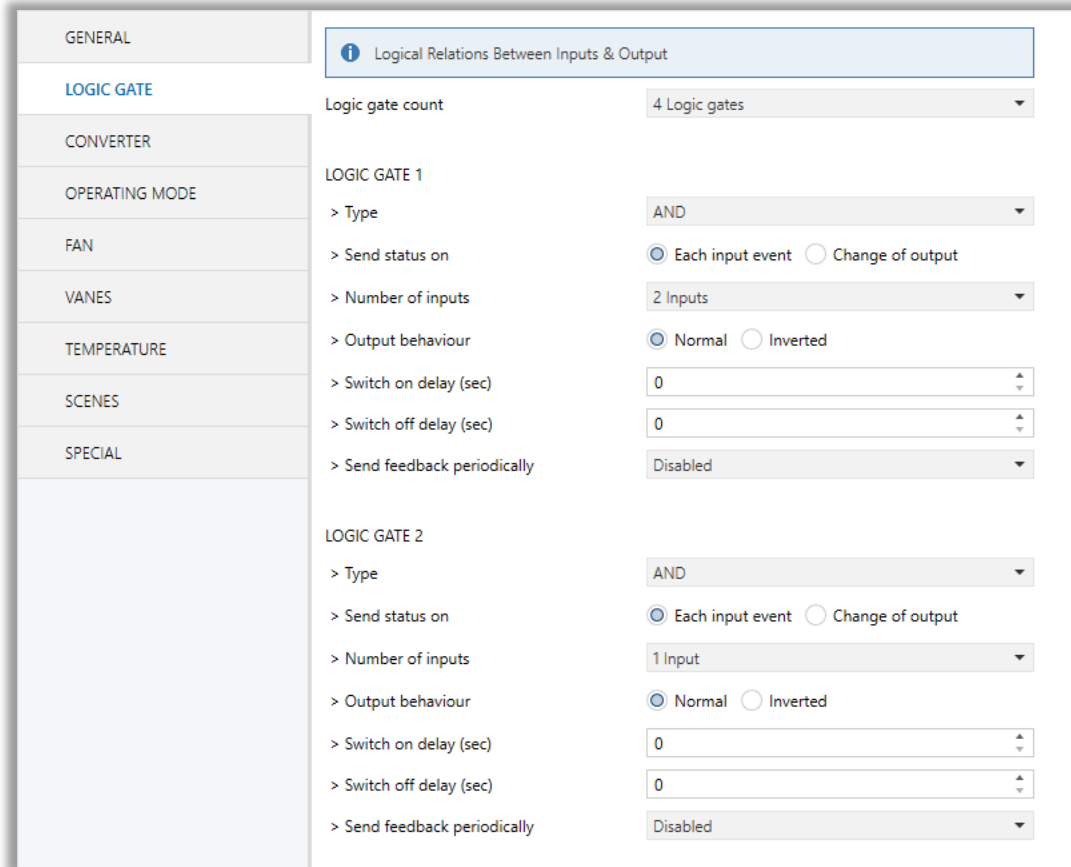

Fig. 7 : Logic Gate Configuration Parameter Page

Up to 4 logic gates can be used with the gateway. In addition, each logic gate allows the use of up to 4 inputs. The standard logic operations AND, OR and XOR are available.

The status of the output of logic gates can be shown normally or inverted. This configuration can be applied via the parameter “Output behaviour” and when it is parameterized as inverted, the status of the output is shown inverted.

Through the parameter “Send status on”, the type of feedback can be defined. The gateway allows sending the result of logic gates when the conversely logic output is changed or when one of the logic inputs is modified. Additionally, it is possible to define a cyclic sending of the feedback which permits getting information about the output status periodically.

The logic output can operate with previously configured delays. The logic output takes the values ON and OFF with delays. Depending on the switch delay parameters configuration, it is possible to set an ON delay (TON), an OFF delay (TOFF) or both at the same time.

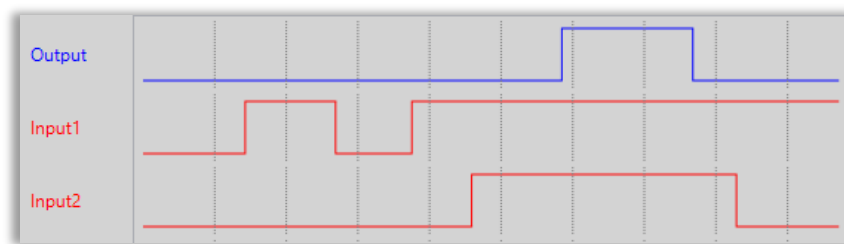

Fig. 8 : Logic Gate with Delays

Special Notes



The number of logical gates can be selected up to 4. Since the characteristics of each gate are the same, only Logic 1 is described.

3.2.1. Parameters List

PARAMETERS	DESCRIPTION	VALUES
Logic Gate Count	This parameter is used to specify the number of logic gates that are used to write logical functions. Up to 4 different logic gates can be used simultaneously.	No logic gate 1 Logic gate 2 Logic gates 3 Logic gates 4 logic gates
LOGIC GATE 1		
> Type	This parameter is used to specify the type of logical gate to be used. There are 3 different logic gate types, AND, OR and XOR. Each logical gate generates a false or true value at its output as a logical association result.	AND OR XOR
> Send status on	This parameter is used to specify how the status of the output will be sent. Each Input Event: Output status will be sent when any logic input is received. Change of Output: Output status will be sent when the logic output is changed.	Each input event Change of output
> Number of inputs	This parameter is used to specify the number of inputs for the logical gate.	1 input 2 inputs 3 inputs 4 inputs
> Output behaviour	This parameter defines the behaviour of the logic output. Normal: The status of the output is sent without any modification. Inverted: If the value is true, the false value will be sent as a status value for the output or vice versa.	Normal Inverted
> Switch on delay (sec)	This parameter is used to set a delay time for output behaviour. The output takes the value ON when real-time reaches the configured time in this parameter.	0...255

<p>> Switch off delay (sec)</p>	<p>This parameter is used to set a delay time for output behaviour. The output takes the value OFF when real-time reaches the configured time in this parameter.</p>	<p>0...255</p>
<p>>Send feedback periodically</p>	<p>This parameter is used to send feedback on the related objects periodically according to the selected time. The objects are listed in the "Feedback at start-up" parameter that is described on the "GENERAL" parameter page above.</p>	<p>Disabled 5sec, 10sec, 30sec, 1min, 5min, 10min, 20min, 30min, 40min, 50min, 1h, 2h, 3h, 4h, 5h, 6h, 12h, 24h</p>

Special Notes



The number of logical gates can be selected up to 4. Since the characteristics of each gate are the same, only one is described.

3.3. Converter

The main parameter settings of the Converter Parameter page are made on this page. Various control options for the Converters are enabled from this page.

GENERAL	Converter gate count	8 Converter gate
LOGIC GATE		
CONVERTER	CONVERTER 1	
	> Input type	1 Byte
	> Calculation	Disabled
OPERATING MODE	> Input value	25
FAN	> Output type	1 Byte
VANES	> Output value	35
TEMPERATURE		
SCENES	CONVERTER 2	
SPECIAL	> Input type	1 Bit
	> Input value	0
	> Output type	1 Bit
	> Output value	0
	CONVERTER 3	
	> Input type	1 Bit
	> Input value	0
	> Output type	1 Bit
	> Output value	0

Fig. 9 : Converter Configuration Parameter Page

Converters are used to convert the output to configured type value depending on the input value. There are 8 different types of data input that can be converted to 4 different data values.

Moreover, if the input is selected as 1 byte or 2 bytes, you can also make the four arithmetical operations (plus, minus, multiply, divide). Some examples are shown below :

<p>Ex 1:</p> <p>Input type: 1 byte, 154</p> <p>Calculation: Plus</p> <p>Calculation value: 7</p> <p>Output type: 1 byte</p> <p>Output = $154 : 7$</p> <p>Output = 22</p>	<p>Ex 2:</p> <p>Input type: 1 byte, 215</p> <p>Calculation: Minus</p> <p>Calculation value: 51</p> <p>Output type: 1 byte</p> <p>Output = $215 - 51$</p> <p>Output = 164</p>
<p>Ex 3:</p> <p>Input type: 2 bytes, 862</p> <p>Calculation: Multiply</p> <p>Calculation value: 49</p> <p>Output type: 2 bytes</p> <p>Output = 862×49</p> <p>Output = 42238</p>	<p>Ex 4:</p> <p>Input type: 2 bytes, 46342</p> <p>Calculation: Divide</p> <p>Calculation value: 986</p> <p>Output type: 2 bytes</p> <p>Output = $46342 : 986$</p> <p>Output = 47</p>

Special Notes



The number of Converters can be selected up to 8. Since the characteristics of each gate are the same, only one is described.

3.3.1. Parameters List

PARAMETERS	DESCRIPTIONS	VALUES
Converter gate count	This parameter is used to determine the number of converter gates. Each converter gate can be set independently.	No converter gate 1 Converter gate 2 Converter gate 3 Converter gate 4 Converter gate 5 Converter gate 6 Converter gate 7 Converter gate 8 Converter gate
CONVERTER 1		
> Input type	<p>This parameter is used to specify the type of input value for the converter input. There are 8 different input values for each converter.</p> <p>When the input type is configured as 1-byte or 2- byte logic, the output data type is set as 1 bit. If the input value is non-zero, the output value will be 1. Otherwise, it will be zero.</p>	1 Bit 2 Bit 1 Byte 2 Byte 1 Byte Logic 2 Byte Logic 1 Byte Threshold 2 Byte Threshold
> Input value	<p>This parameter is used to set the value of the converter input. Several value types can be selected and these possible values are described below.</p> <p>The input type is 1 Bit : If the input type is selected as 1 bit, values are between 0-1.</p> <p>The input type is 2 Bit : If the input type is selected as 2 bits, values are between 0-3.</p> <p>The input type is 1 Byte : If the input type is selected as 1 byte, values are between 0-255.</p> <p>The input type is 2 Byte : If the input type is selected as 2 bytes, values are between 0-65536.</p>	0...1 0...3 0...255 0...65535

	<p>The input type is 1 Byte logic : If the input type is selected as 1-byte logic, values are between 0-255.</p> <p>The input type is 2 Byte logic : If the input type is selected as 2-byte logic, values are between 0-65536.</p> <p>The input type is 1 Byte Threshold : If the input type is selected as a 1-byte threshold, values are between 0-255.</p> <p>The input type is 2 Byte Threshold : If the input type is selected as the 2-byte threshold, values are between 0-65536.</p>	
Calculation	<p>This parameter is used to perform a mathematical operation with the input value.</p> <p>Disabled: Calculation value is disabled. The input value is converted to output value without a mathematical operation.</p> <p>Plus: The calculation value is summed with the input value.</p> <p>Minus: The calculation value is subtracted from the input value</p> <p>Multiply: Input value and calculation value are multiplied and the result is applied to the output value.</p> <p>Divide: The input value is divided by the calculation value and the result is applied to the output value.</p>	<p>Disabled</p> <p>Plus</p> <p>Minus</p> <p>Multiply</p> <p>Divide</p>
Calculation Value	<p>This parameter is used to specify the value to be processed along with the input value. This value type is the same as the output value type.</p>	<p>0...255</p> <p>0...65535</p>
Lower Limit	<p>This parameter is used to set the lower limit value of the threshold for the input when the input is configured as 1 byte or 2-byte threshold.</p>	<p>0...255</p> <p>0...65535</p>

<p>Higher Limit</p>	<p>This parameter is used to set the higher limit value of the threshold for the input when the input is configured as 1 byte or 2-byte threshold.</p>	<p>0...255 0...65535</p>
<p>Output type</p>	<p>This parameter is used to specify the type of output value for the converter output. There are 4 different output values for each converter.</p>	<p>1 Bit 2 Bit 1 Byte 2 Byte</p>
<p>Output value</p>	<p>This parameter is used to set the value of the converter output. Several value types can be selected and these possible values are described below.</p> <p>The output type is 1 Bit : If the input type is selected as 1 bit, values are between 0-1.</p> <p>The output type is 2 Bit : If the input type is selected as 2 bits, values are between 0-3.</p> <p>The output type is 1 Byte : If the input type is selected as 1 byte, values are between 0-255.</p> <p>The output type is 2 Byte : If the input type is selected as 2 bytes, values are between 0-65536.</p>	<p>0...1 0...3 0...255 0...65535</p>

3.4. Operating Mode

In this section, all of the parameters are corresponding to different mode properties and communication objects. Some parameters of related objects and their tasks are described below.

- Operating Mode Heat/Cool object (1 bit) : The operating mode of the air conditioner can be selected as the heating mode or cooling mode with this 1-bit object.
- Operating mode +/- object (1 bit) : Using this object 5 different operating modes can be selected. The selection can be made with 1-bit values. Switching between the modes is done according to the following condition :

GENERAL	Operating mode Heat/Cool object (1-bit)	Disabled
LOGIC GATE	Operating mode +/- object (1-bit)	Disabled
CONVERTER	Operating mode individual objects (1-bit)	<input type="radio"/> Disabled <input checked="" type="radio"/> Enabled
OPERATING MODE	Operating mode object (1-byte)	<input type="radio"/> Disabled <input checked="" type="radio"/> Enabled
FAN	Operating mode percent value objects	<input type="radio"/> Disabled <input checked="" type="radio"/> Enabled
VANES	> Priority to "Operating mode Heat/Cool"	<input checked="" type="radio"/> Disabled <input type="radio"/> Enabled
TEMPERATURE	Feedback operating mode individual objects (1-bit)	<input type="radio"/> Disabled <input checked="" type="radio"/> Enabled
SCENES	Feedback operating mode object (1-byte)	<input type="radio"/> Disabled <input checked="" type="radio"/> Enabled
SPECIAL	Feedback operating mode text object (14-char)	<input checked="" type="radio"/> Disabled <input type="radio"/> Enabled
	Energy Saver mode	<input type="radio"/> Disabled <input checked="" type="radio"/> Enabled
	> Polarity	<input checked="" type="radio"/> 1:Start / 0:Stop <input type="radio"/> 0:Start / 1:Stop
	> Timer	Disabled
	> Setpoint shifting	<input checked="" type="radio"/> Via parameter <input type="radio"/> Via communication object
	> Value (°C)	1
	> Fan speed	<input checked="" type="radio"/> Via parameter <input type="radio"/> Via communication object
	> Value (fan)	No change
	Power Saver mode	<input checked="" type="radio"/> Disabled <input type="radio"/> Enabled
	Winter mode	<input checked="" type="radio"/> Disabled <input type="radio"/> Enabled
	Summer mode	<input checked="" type="radio"/> Disabled <input type="radio"/> Enabled

Fig. 10 : Operating Modes Sequences

- Operating Mode Individual objects (1-bit): The operating mode can be modified by sending value 1 to the desired mode object.

- Operating Mode: The operating mode can be modified with these values that are shown in the table below:

OPERATING MODE	VALUE
AUTO	0
HEAT	1
COOL	3
FAN	9
DRY	14

- Operating Mode Percent Value Objects: Via these 1-byte objects the indoor unit can be controlled via percentage values to provide compatibility with the thermostat that use this data type. By using this object, there are two different options:
- Priority to "Operating mode Heat/Cool": Disabled

When the priority of "Operating mode Heat/Cool" is disabled, it does not matter what is the current mode of the indoor unit, the percentage values can switch the mode and activate the indoor unit in the following way:

- If the object "Heating Mode Percent Value" takes a value greater than 0, the indoor unit will be switched ON in HEAT mode. The value 0 will switch off the air conditioner.
- If the object "Cooling Mode Percent Value" takes a value greater than 0, the indoor unit will be switched ON in COOL mode. The value 0 will switch off the air conditioner.

Special Notes



When the priority is disabled and the air condition unit is working as FAN, AUTO or DRY modes, a new value to the objects "Heating/Cooling Mode Percent Value" or "Operating Mode Heat/Cool" will change the mode to HEAT or COOL.

- Priority to "Operating mode Heat/Cool": Enabled

When the priority is enabled, the operating mode defined cannot be modified by the percentage value objects and the behaviour will be as follow:

Actual operating mode as HEAT;

- If the object "Heating Mode Percent Value" takes a value greater than 0, the indoor unit will be switched ON. The value 0 will switch off the air conditioner.
- Any data received via the object "Cooling Mode Percent Value" will not be taken into consideration.

Actual operating mode as COOL;

- If the object “Cooling Mode Percent Value” takes a value greater than 0, the indoor unit will be switched ON. The value 0 will switch off the air conditioner.
- Any data received via the object “Heating Mode Percent Value” will not be taken into consideration.

Special Notes



When the priority is enabled and the air condition unit is working as FAN, AUTO or DRY modes, a new value to the objects “Heating/Cooling Mode Percent Value” will not be taken into consideration. Only a new value to the object “Operating Mode Heat/Cool” will change the mode to HEAT or COOL.

Special Notes



Any modification on all above objects will be advised in the following feedback objects:

- Feedback Operating Mode Heat/Cool
- Feedback Individual Mode Auto
- Feedback Individual Mode Heat
- Feedback Individual Mode Cool
- Feedback Individual Mode Fan
- Feedback Individual Mode Dry
- Feedback Operating Mode
- Feedback Operating Mode Text

In this parameter configuration page, there are also some different special modes for operating the air conditioner. These 4 different modes are described below respectively.

Energy Saver Mode : The energy saver mode can be applied via the object “Energy Saver Mode”. This mode can be configured to work during a period or the “stop” value is received. Via the parameter or via communication object “Timer” period can be set. If the timer is disabled, the “Energy Saver Mode” will be finished at the following actions:

- The object “Energy Saver Mode” receives the “stop” value, the mode will stop and the previous state will be recovered at this moment.
- A new value for fan, mode or set point is received via KNX, the Energy Saver Mode will stop and the new value will be applied at this moment.

If the timer is enabled, the energy saver mode will be finished at the below situation or once the time is elapsed. Then the previous state will be recovered. The timer can always be re-triggerable by sending the start value to the object “Energy Saver Mode”.

The timer, variation of the set point and the fan speed to be applied during the energy saver mode can be selected via parameter or communication object. With this last option, the user could modify the values at any time as required.

Special Notes



If the timer, set point shifting or fan speed values are modified via their respective objects (“Energy Saver Mode Timer Duration”, “Energy Saver Mode Setpoint Shifting” and “Energy Saver Mode Fan Speed”) while the energy saver mode is active, the new values will be directly applied.

Power Saver Mode : The power saver mode can be applied via the object “. This mode can be configured to work during a period or during the “stop” value is received. Via the parameter “Timer” period can be selected. If the timer is disabled, the “Power Saver Mode” will be finished at the following actions:

- The object “Power Saver Mode” receives the “stop” value, the mode will stop and the previous state will be recovered at this moment.
- A new value for fan, mode or set point is received via KNX, the Power Saver Mode will stop and the new value will be applied at this moment.

If the timer is enabled, the energy saver mode will be finished at the below situation or once the time is elapsed. Then the previous state will be recovered. The timer can always be re-triggerable by sending the start value to the object “Power Saver Mode”.

The timer, variation of the set point and the fan speed to be applied during the energy saver mode can be selected via parameter or communication object. With this last option, the user could modify the values at any time as required.

Special Notes



If the timer, set point shifting or fan speed values are modified via their respective objects (“Power Saver Mode Timer Duration”, “Power Saver Mode Setpoint Shifting” and “Power Saver Mode Fan Speed”) while the energy saver mode is active, the new values will be directly applied.

Winter Mode : The winter mode can be applied via the object “Winter Mode”. If the winter mode is applied while the operating is mode is COOL, the mode will be automatically changed to HEAT mode and the unit indoor will switch on.

This mode can be configured to work during a period or the “stop” value is received. Via the parameter “Timer for winter mode” this can be selected. If the timer is disabled, the winter mode will be finished once the object “Winter Mode” receives the “stop” value. At this moment the mode will stop and the previous state will be recovered.

If the timer is enabled, the winter mode will be finished at bellow action or once the time is elapsed. Then the previous state will be recovered.

- A new value for fan, mode or set point is received via KNX or remote control will be directly applied and then the winter mode will be disabled. However, the previous status will be recovered and the air conditioner will remain the winter mode values applied.

The timer, set point and the fan speed to be applied during the winter mode can be selected via parameter or communication object. With this last option, the user could modify the values every time as required.

Special Notes



If the timer, set point or fan speed values are modified via their respective objects (“Winter Mode Timer Duration”, “Winter Mode Setpoint Shifting” and “Winter Mode Fan Speed”) while the winter mode is active, the new values will be directly applied.

Summer Mode : The summer mode can be applied via the object “Summer Mode”. If the summer mode is applied while the operating is mode is HEAT, the mode will be automatically changed to COOL mode and the unit indoor will switch on.

This mode can be configured to work during a period or the “stop” value is received. Via the parameter “Timer for summer mode” this can be selected. If the timer is disabled, the “Summer Mode” will be finished once the object “Summer Mode” receives the “stop” value. At this moment the mode will stop and the previous state will be recovered.

If the timer is enabled, the summer mode will be finished at below action or once the time is elapsed. Then the previous state will be recovered.

- A new value for fan, mode or set point is received via KNX or remote control will be directly applied and then the winter mode will be disabled. However, the previous status will be recovered and the air conditioner will remain the winter mode values applied.

The timer, set point and the fan speed to be applied during the winter mode can be selected via parameter or communication object. With this last option, the user could modify the values every time as required.

Special Notes



If the timer, set point or fan speed values are modified via their respective objects (“Summer Mode Timer Duration”, “Summer Mode Setpoint Shifting” and “Summer Mode Fan Speed”) while the summer mode is active, the new values will be directly applied.

All parameters described in this section are set on the operating mode parameter page.

Special Notes



All of the parameters of energy saver mode in the above parameter page image are the same for winter, power saver and summer mode. When these modes are activated, the parameters will have appeared.

3.4.1. Parameters List

PARAMETERS	DESCRIPTION	VALUES
Operating mode Heat/Cool object (1-bit)	<p>This parameter is used to enable or disable the operating mode heat/cool and its feedback objects.</p> <p>1:Heat/0:Cool : If value 1 is sent via a related object, the air conditioner switches to heat mode.</p> <p>0:Heat/1:Cool : If value 1 is sent via a related object, the air conditioner switches to cool mode.</p>	<p>Disabled</p> <p>1:Heat/0:Cool</p> <p>0:Heat/1:Cool</p>
Operating mode +/- object (1-bit)	<p>This parameter is used to enable or disable the operating mode +/- object.</p> <p>1:Increase/0:Decrease: If the value 1 is sent, the modes switch according to the following sequence Auto->Heat->Cool->Fan->Dry</p> <p>0:Up/1:Down: If the value 0 is sent, the modes switch according to the following sequence Auto->Heat->Cool->Fan->Dry</p>	<p>Disabled</p> <p>1:Increase/0:Decrease</p> <p>0:Up/1:Down</p>
Operating mode individual objects (1-bit)	<p>This parameter is used to enable the operating modes' individual objects. These objects are :</p> <ul style="list-style-type: none"> ->Individual Mode Heat ->Individual Mode Cool ->Individual Mode Auto ->Individual Mode Fan ->Individual Mode Dry 	<p>Disabled</p> <p>Enabled</p>
Operating mode object (1-byte)	<p>This parameter is used to enable or disable the operating mode object. Via this object, if the specified values are sent to the corresponding mode the operating mode is switched to that mode.</p>	<p>Disabled</p> <p>Enabled</p>
Operating mode percent value objects	<p>This parameter is used to enable the percent value objects of heating mode and cooling mode.</p>	<p>Disabled</p> <p>Enabled</p>
> Priority to "Operating mode Heat/Cool"	<p>This parameter is used to enable or disable the giving priority to operating mode Heat/Cool.</p>	<p>Disabled</p> <p>Enabled</p>

Feedback operating mode individual objects (1-bit)	This parameter is used to enable or disable the feedback objects of individual operating mode objects. If this parameter is enabled, all of the individual feedback objects of operating modes are visible.	Disabled Enabled
Feedback operating mode object (1-byte)	This parameter is used to enable or disable the 1-byte feedback object of the operating mode. According to special values, the operating mode can be easily detected.	Disabled Enabled
Feedback operating mode text object (14-char)	This parameter is used to enable or disable the feedback operating text mode objects.	Disabled Enabled
-> Text for mode AUTO	This parameter is used to type a special name for the operating mode AUTO feedback text object.	-
-> Text for mode HEAT	This parameter is used to type a special name for the operating mode HEAT feedback text object.	-
-> Text for mode COOL	This parameter is used to type a special name for the operating mode COOL feedback text object.	-
-> Text for mode FAN	This parameter is used to type a special name for the operating mode FAN feedback text object.	-
-> Text for mode DRY	This parameter is used to type a special name for the operating mode DRY feedback text object.	-
Energy Saver		
Energy Saver mode	This parameter is used to enable or disable the energy saver mode.	Disabled Enabled
> Polarity	This parameter is used to specify the polarity of the energy saver mode for enabling it according to this configuration. 1:Start/0:Stop: If the value 1 is sent, energy saver mode will be started. 0:Start/1:Stop: If the value 0 is sent, energy saver mode will be started.	1:Start/0:Stop 0:Start/1:Stop
> Timer	This parameter is used to set a timer for energy saver mode with a 1-byte value.	Disabled Via parameter

	<p>Via parameter: Timer interval value will be set via this parameter page.</p> <p>Via communication object: Timer interval value will be set via a communication object.</p>	Via communication object
> Interval (min)	This parameter is used to specify the timer interval value via parameter.	0...255
> Setpoint	<p>This parameter is used to select the setpoint shifting method.</p> <p>Via parameter: The setpoint will be determined according to the parameter value</p> <p>Via communication object: The setpoint will be determined via communication object value.</p>	<p>Via parameter</p> <p>Via communication object</p>
> Value (°C)	This parameter is used to specify the setpoint shifting value via parameter.	1...4
> Fan speed	This parameter is used to specify the fan speed value when the air conditioner switches to energy saver mode.	<p>Via parameter</p> <p>Via communication object</p>
> Value (fan)	This parameter is used to select the fan speed levels from the parameter list.	<p>No change</p> <p>Auto</p> <p>Fan 1</p> <p>Fan 2</p> <p>Fan 3</p>
Power Saver		
Power Saver mode	This parameter is used to enable or disable the power saver mode.	<p>Disabled</p> <p>Enabled</p>
> Polarity	<p>This parameter is used to specify the polarity of the power saver mode for enabling it according to this configuration.</p> <p>1:Start/0:Stop: If the value 1 is sent, power saver mode will be started.</p> <p>0:Start/1:Stop: If the value 0 is sent, power saver mode will be started.</p>	<p>1:Start/0:Stop</p> <p>0:Start/1:Stop</p>
> Timer	This parameter is used to set a timer for power saver mode with a 1-byte value.	<p>Disabled</p> <p>Via parameter</p>

	<p>Via parameter: Timer interval value will be set via this parameter page.</p> <p>Via communication object: Timer interval value will be set via a communication object.</p>	Via communication object
> Interval (min)	This parameter is used to specify the timer interval value via parameter.	0...255
> Setpoint	<p>This parameter is used to select the setpoint shifting method.</p> <p>Via parameter: The setpoint will be determined according to the parameter value</p> <p>Via communication object: The setpoint will be determined via communication object value.</p>	<p>Via parameter</p> <p>Via communication object</p>
> Value (°C)	This parameter is used to specify the setpoint shifting value via parameter.	1...4
> Fan speed	This parameter is used to specify the fan speed value when the air conditioner switches to power saver mode.	<p>Via parameter</p> <p>Via communication object</p>
> Value (fan)	This parameter is used to select the fan speed levels from the parameter list.	<p>No change</p> <p>Auto</p> <p>Fan 1</p> <p>Fan 2</p> <p>Fan 3</p>
Winter		
Winter mode	This parameter is used to enable or disable the winter mode.	<p>Disabled</p> <p>Enabled</p>
> Polarity	<p>This parameter is used to specify the polarity of the winter mode for enabling it according to this configuration.</p> <p>1:Start/0:Stop: If the value 1 is sent, winter mode will be started.</p> <p>0:Start/1:Stop: If the value 0 is sent, winter mode will be started.</p>	<p>1:Start/0:Stop</p> <p>0:Start/1:Stop</p>
> Timer	This parameter is used to set a timer for winter mode with a 1-byte value.	<p>Disabled</p> <p>Via parameter</p>

	<p>Via parameter: Timer interval value will be set via this parameter page.</p> <p>Via communication object: Timer interval value will be set via a communication object.</p>	Via communication object
> Interval (min)	This parameter is used to specify the timer interval value via parameter.	0...255
> Setpoint shifting	<p>This parameter is used to select the setpoint shifting method.</p> <p>Via parameter: The setpoint will be shifted according to the parameter value</p> <p>Via communication object: The setpoint will be shifted via communication object value.</p>	<p>Via parameter</p> <p>Via communication object</p>
> Value (°C)	This parameter is used to specify the setpoint shifting value via parameter.	16...18...30
> Fan speed	This parameter is used to specify the fan speed value when the air conditioner switches to winter mode.	<p>Via parameter</p> <p>Via communication object</p>
> Value (fan)	This parameter is used to select the fan speed levels from the parameter list.	<p>No change</p> <p>Auto</p> <p>Fan 1</p> <p>Fan 2</p> <p>Fan 3</p>
Summer		
Summer mode	This parameter is used to enable or disable the summer mode.	<p>Disabled</p> <p>Enabled</p>
> Polarity	<p>This parameter is used to specify the polarity of the summer mode for enabling it according to this configuration.</p> <p>1:Start/0:Stop: If the value 1 is sent, summer mode will be started.</p> <p>0:Start/1:Stop: If the value 0 is sent, summer mode will be started.</p>	<p>1:Start/0:Stop</p> <p>0:Start/1:Stop</p>
> Timer	This parameter is used to set a timer for summer mode with a 1-byte value.	<p>Disabled</p> <p>Via parameter</p>

	<p>Via parameter: Timer interval value will be set via this parameter page.</p> <p>Via communication object: Timer interval value will be set via a communication object.</p>	Via communication object
> Interval (min)	This parameter is used to specify the timer interval value via parameter.	0...255
> Setpoint shifting	<p>This parameter is used to select the setpoint shifting method.</p> <p>Via parameter: The setpoint will be shifted according to the parameter value</p> <p>Via communication object: The setpoint will be shifted via communication object value.</p>	<p>Via parameter</p> <p>Via communication object</p>
> Value (°C)	This parameter is used to specify the setpoint shifting value via parameter.	16...18...30
> Fan speed	This parameter is used to specify the fan speed value when the air conditioner switches to summer mode.	<p>Via parameter</p> <p>Via communication object</p>
> Value (fan)	This parameter is used to select the fan speed levels from the parameter list.	<p>No change</p> <p>Auto</p> <p>Fan 1</p> <p>Fan 2</p> <p>Fan 3</p>

3.5. Fan

In this parameter page, the parameter “Fan mode available” defines if the fan mode is available in the indoor unit. If this parameter is set to “No”, all the fan parameters and objects are hidden. All the parameters in this section are related to the Fan Speed properties and communication objects.

GENERAL	Fan mode available	<input type="radio"/> No <input checked="" type="radio"/> Yes
LOGIC GATE	Number of fan level	2
CONVERTER	AUTO fan mode available	<input type="radio"/> No <input checked="" type="radio"/> Yes
OPERATING MODE	Fan level control +/- object (1-bit)	0:Up / 1:Down
FAN	> Include AUTO fan mode in the sequence	<input checked="" type="radio"/> No <input type="radio"/> Yes
VANES	> Loop the sequence	<input checked="" type="radio"/> No <input type="radio"/> Yes
TEMPERATURE	Fan level control individual objects (1-bit)	<input type="radio"/> Disabled <input checked="" type="radio"/> Enabled
SCENES	Fan level control & feedback objects (1-byte)	Scaling
SPECIAL	> Fan 1 lower limit (%)	0
	> Fan 2 lower limit (%)	0
	Feedback fan level individual objects (1-bit)	<input type="radio"/> Disabled <input checked="" type="radio"/> Enabled
	Feedback fan level text object (14-char)	<input type="radio"/> Disabled <input checked="" type="radio"/> Enabled
	> Text for speed AUTO	
	> Text for fan speed 1	
	> Text for fan speed 2	

Fig. 11 : FAN Configuration Parameter Page

Once the fan mode is enabled, the number of available fan levels in the indoor unit should be defined via the parameter “Number of fan level”. Besides the parameter “AUTO fan mode available” defines if the AUTO fan mode is available in the indoor unit.

Special Notes



Please, do not forget to read the documentation of your indoor unit to check how many fan speeds are available.

Fan Level Control:

The fan level can be set via some different methods:

- Fan level can be selected by sending 1-bit values. While using this method the following sequences are applied
- If auto mode is in the sequence, the fan level is selected as 3 and loop the sequence parameter is enabled, the changeovers between the fan levels like the following figure. With the fan speed +/- object value 1 or value 0 can be sent to switch between the modes sequentially.

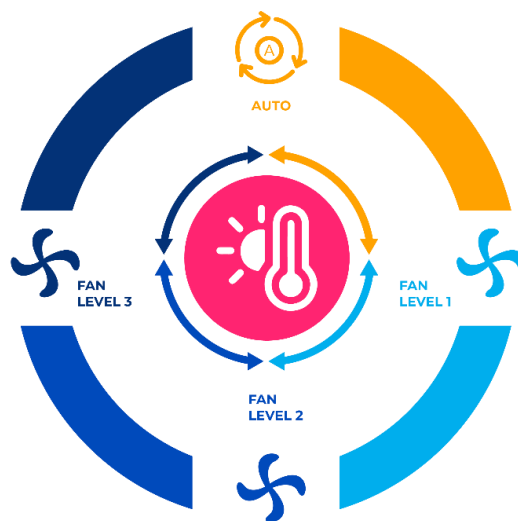

Fig. 12 : 3 Fan Levels + Auto Mode with Loop Representation

- If auto mode is in the sequence, the fan level is selected as 2 and loop the sequence parameter is enabled, the changeovers between the fan levels like the following figure. With the fan speed +/- object value 1 or value 0 can be sent to switch between the modes sequentially.



Fig. 13 : 2 Fan Levels + Auto Mode with Loop Representation

- If the fan level is selected as 3 and the loop the sequence parameter is enabled, the changeovers between the fan levels like the following figure. With the fan speed +/- object value 1 or value 0 can be sent to switch between the modes sequentially.

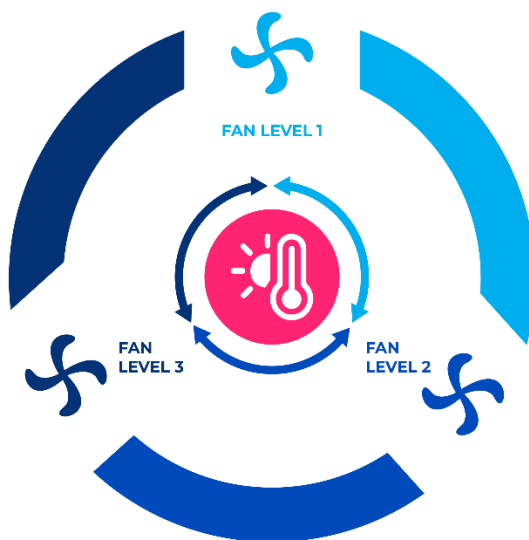

Fig. 14 : 3 Fan Levels with Loop Representation

- If the fan level is selected as 2 and the loop the sequence parameter is enabled, the changeovers between the fan levels like the following figure. With the fan speed +/- object value 1 or value 0 can be sent to switch between the modes sequentially.

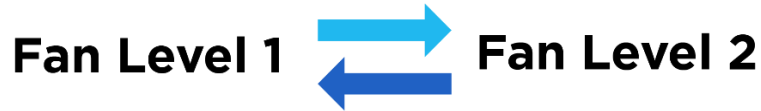

Fig. 15 : 2 Fan Levels with Loop Representation

- If the fan level is selected as 3, auto mode is enabled and the loop the sequence parameter is disabled, the changeovers between the fan levels like the following figure. With the fan speed +/- object value 1 or value 0 can be sent to switch between the modes sequentially.

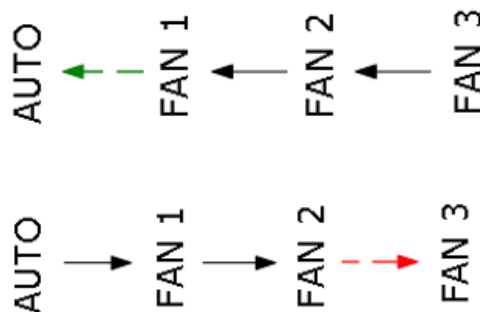

Fig. 16 : 3 Fan Levels + Auto Mode Without Loop Representation

- ❖ Fan speeds can be activated via percentage values. The thresholding values for each fan speed are set in the parameters “Fan (1, 2, 3) lower limit”.
- ❖ Fan speed can be activated by sending the numbers of each speed 1,2 or 3.

Special Notes



If a value greater than 3 or the value 0 is received, this data will be discarded and the fan will remain at the current speed.

Special Notes



Any modification on all above objects will be advised in the following feedback objects:
Feedback Fan Speed Enumerated
Feedback Fan Speed Manual/Auto, Feedback Individual Fan Speed 1, Feedback Individual Fan speed 2, Feedback Individual Fan speed 3.
Feedback Fan Speed Text

3.5.1. Parameters List

PARAMETERS	DESCRIPTION	VALUES
Fan mode available	This parameter is used to enable or disable the fan mode.	No Yes
Number of fan level	This parameter is used to select the fan level of the air conditioner.	2...3
AUTO fan mode available	This parameter is used to enable the AUTO fan mode to be activated.	No Yes
Fan level control +/- object (1-bit)	<p>This parameter is used to enable or disable the fan level control +/- object.</p> <p>1:Increase/0:Decrease: If the value 1 is sent, the fan levels switch according to the following sequence Auto->Fan Level 1-> Fan Level 2->Fan Level 3</p> <p>0:Up/1:Down: If the value 1 is sent, the fan levels switch according to the following sequence Fan Level 3-> Fan Level 2->Fan Level 1->Auto</p>	<p>Disabled</p> <p>0:Up/1:Down</p> <p>1:Increase/0:Decrease</p>
> Include AUTO fan mode in the sequence	This parameter is used to add AUTO fan mode to fan levels.	No Yes
> Loop the sequence	This parameter is used to enable or disable the fan level sequence repeating considering the selected parameter polarity.	No Yes
Fan level control individual objects (1-bit)	<p>This parameter is used to enable or disable the fan level control individual objects. For each fan speed level, there is an individual fan speed object. These objects are:</p> <p>Individual Fan Speed 1</p> <p>Individual Fan Speed 2</p> <p>Individual Fan Speed 3</p>	<p>Disabled</p> <p>Enabled</p>
Fan level control & control feedback objects (1-byte)	<p>This parameter is used to determine the fan level control type with 1-byte communication objects</p> <p>Scaling: Via scaling object, according to the threshold defined in parameters fan speed will be determined.</p>	<p>Disabled</p> <p>Scaling</p> <p>Enumerated</p>

	Enumerated: Via enumerated object, if value 1 is sent fan level will be fan speed 1. Likewise, value 2 causes fan speed 2 and value 3 causes fan speed 3.	
> Fan 1 lower limit (%)	This parameter is used to set the lower limit 1 fan level threshold value to compare with the received value from the KNX bus line. After comparison, the corresponding fan speed will be chosen.	0...100
> Fan 2 lower limit (%)	This parameter is used to set the lower limit 2 fan level threshold value to compare with the received value from the KNX bus line. After comparison, the corresponding fan speed will be chosen.	0...100
> Fan 3 lower limit (%)	This parameter is used to set the lower limit 3 fan level threshold value to compare with the received value from the KNX bus line. After comparison, the corresponding fan speed will be chosen.	0...100
Fan level individual objects (1-bit)	This parameter is used to enable or disable the individual fan level objects.	Disabled Enabled
Feedback fan level text object (14-char)	This parameter is used to enable or disable the feedback fan level text object.	Disabled Enabled
-> Text for mode AUTO	This parameter is used to type a special name for AUTO mode.	-
-> Text for fan speed 1	This parameter is used to type a special name for fan speed 1.	-
-> Text for fan speed 2	This parameter is used to type a special name for fan speed 2.	-
-> Text for fan speed 3	This parameter is used to type a special name for fan speed 3.	-

3.6. Vanes

On this parameter page, all the parameters are related to the Vanes properties and communication objects. The parameter “Vanes control available” defines if the vanes control is available in the indoor unit. If this parameter is set to “No”, all the fan parameters and objects are hidden.

GENERAL	Vanes control available	<input type="radio"/> No <input checked="" type="radio"/> Yes
LOGIC GATE	Available vanes positions	4
CONVERTER	Vanes control +/- objects (1-bit)	1:Increase / 0:Decrease
OPERATING MODE	> Include SWING vanes mode in the sequence	<input checked="" type="radio"/> No <input type="radio"/> Yes
FAN	> Loop the sequence	<input checked="" type="radio"/> No <input type="radio"/> Yes
VANES	Vanes control individual objects (1-bit)	<input type="radio"/> Disabled <input checked="" type="radio"/> Enabled
TEMPERATURE	Vanes control & feedback objects (1-byte)	Scaling
SCENES	> Vanes position 1 lower limit	0
SPECIAL	> Vanes position 2 lower limit	0
	> Vanes position 3 lower limit	0
	> Vanes position 4 lower limit	0
	Feedback vanes control individual objects (1-bit)	<input type="radio"/> Disabled <input checked="" type="radio"/> Enabled
	Feedback vanes control text objects (14-char)	<input type="radio"/> Disabled <input checked="" type="radio"/> Enabled
	> Text for vanes SWING	SWING
	> Text for vanes Position 1	POSITION 1
	> Text for vanes Position 2	POSITION 2
	> Text for vanes Position 3	POSITION 3
	> Text for vanes Position 4	POSITION 4

Fig. 17 : Vanes Configuration Parameter Page

Once the vane control is enabled, the number of available positions in the indoor unit should be defined via the parameter “Available vanes positions”.

Vanes Control:

The vanes position can be set via some different methods:

- Vane position can be controlled by sending 1-bit values. While using this method the following sequence is applied :

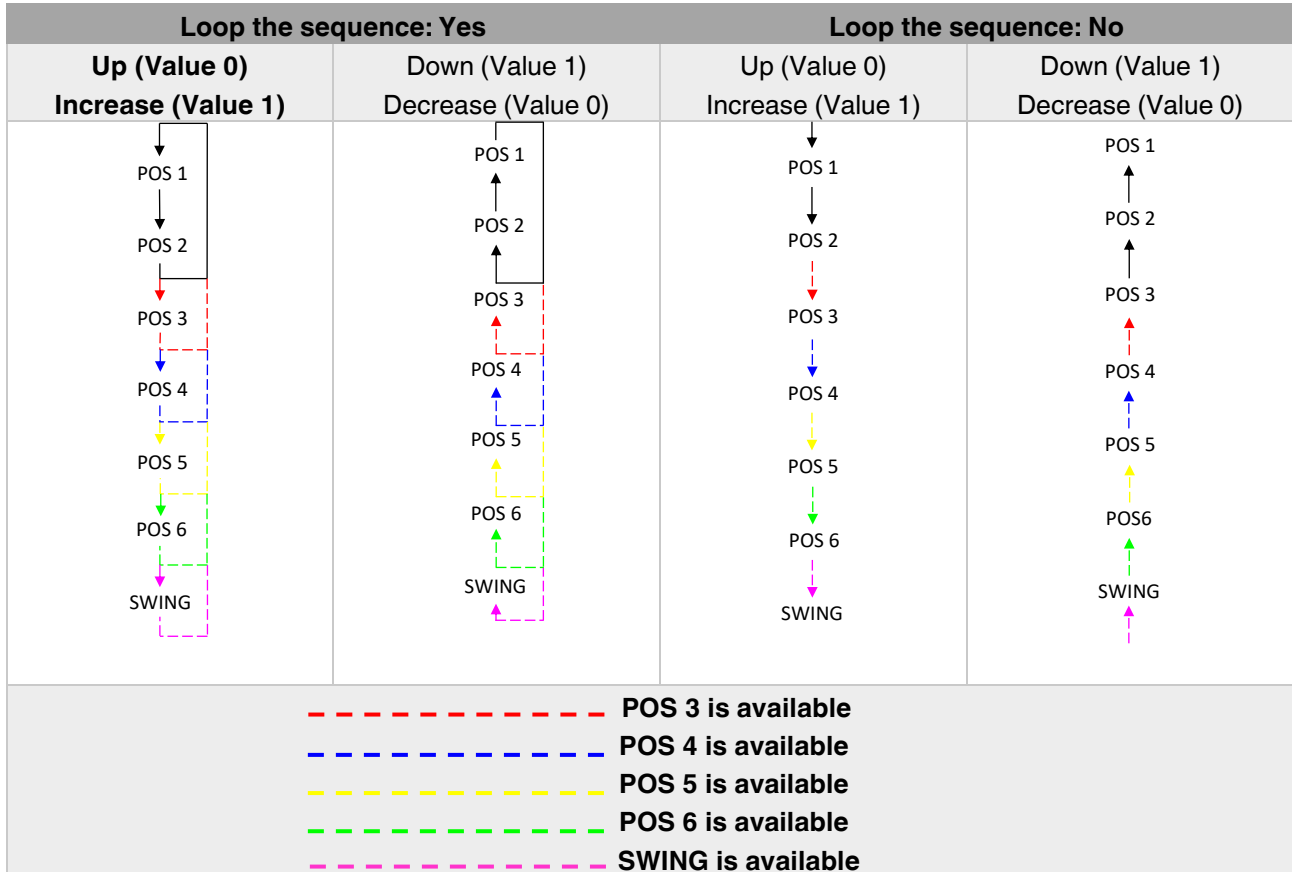

- Vane positions can be controlled via percentage values. The thresholding values for each position are set in the parameters “Vanes position (1, 2, 3, 4, 5, 6) lower limit”.
- Vane positions can be controlled by sending the numbers of each position: 1, 2, 3, 4, 5 or 6.

Special Notes



If a value greater than 6 or the value 0 is received, this data will be discarded and the vanes will remain in the current position.

Special Notes



Any modification on all above objects will be advised in the following feedback objects:
Feedback Vanes Position Percent / Enumerated
Feedback Vanes Position Manual/Auto, Feedback Vanes Position 1, Feedback Vanes Position 2, Feedback Vanes Position 3, Feedback Vanes Position 4, Feedback Vanes Position 5, Feedback Vanes Position 6 and Feedback Vanes Swing.
Feedback Vanes Position Text.

3.6.1. Parameters List

PARAMETERS	DESCRIPTION	VALUES
Vanes control available	This parameter is used to enable or disable the vanes control function. If this parameter is selected as yes, all of the vanes parameters will be visible.	No Yes
Available vanes positions	This parameter is used to select the positions of the vanes. The vane position value should be selected correctly according to the indoor unit.	3..6
Vanes control +/- objects (1-bit)	<p>This parameter is used to enable the vanes control object to change the desired vane position.</p> <p>1:Increase/0:Decrease: If the value 1 is sent, the vane position switches according to the following sequence</p> <p>Swing->Pos 1->Pos 2->Pos 3->Pos 4->Pos 5->Pos 6.</p> <p>0:Up/1:Down: If the value 1 is sent, the vane position switches according to the following sequence</p> <p>Swing->Pos 1->Pos 2->Pos 3->Pos 4->Pos 5->Pos6.</p>	<p>Disabled</p> <p>1:Increase/0:Decrease</p> <p>0:Up/1:Down</p>
> Include SWING vanes mode in the sequence	This parameter is used to include the SWING function in the vane position sequence. If vanes position is selected as 5, the SWING feature will come from after the pos 5 in the sequence.	No Yes
> Loop the sequence	This parameter is used to control the sequence in a loop. According to vanes position +/- object configuration polarity, the sequence will be repeated.	No Yes
Vanes control individual objects (1-bit)	This parameter is used to enable or disable the individual vanes control objects. When a '1' value is sent to a related individual object, the position of the vanes is set to the corresponding object position. If this object is "vane set position 2" and 1 value is sent, the vane position will be position 2.	Disabled Enabled

Vanes control & feedback objects (1-byte)	<p>This parameter is used to determine the vanes control type with 1-byte communication objects. This parameter also enables the corresponding feedback objects.</p> <p>Scaling: Via scaling object, according to the threshold defined in parameters vane position will be determined.</p> <p>Enumerated: Via enumerated object, if value 1 is sent vane position will be position 1. Likewise, value 2 causes vane position 2 and value 3 causes vane position 3 and so on.</p>	<p>Disabled</p> <p>Scaling</p> <p>Enumerated</p>
> Vanes position 1 lower limit	This parameter is used to specify the vane position 1 lower limit.	0...100
> Vanes position 2 lower limit	This parameter is used to specify the vane position 2 lower limit.	0...100
> Vanes position 3 lower limit	This parameter is used to specify the vane position 3 lower limit.	0...100
> Vanes position 4 lower limit	This parameter is used to specify the vane position 4 lower limit.	0...100
> Vanes position 5 lower limit	This parameter is used to specify the vane position 5 lower limit.	0...100
> Vanes position 6 lower limit	This parameter is used to specify the vane position 6 lower limit.	0...100
Feedback vanes control individual objects (1-bit)	This parameter is used to enable or disable the individual fan level objects.	<p>Disabled</p> <p>Enabled</p>
Feedback vanes control text objects (14-char)	This parameter is used to enable or disable the feedback vanes text object.	<p>Disabled</p> <p>Enabled</p>
> Text for vanes SWING	This parameter is used to type a special name for the SWING function.	SWING
> Text for vanes Position 1	This parameter is used to type a special name for vane position 1.	POSITION 1

> Text for vanes Position 2	This parameter is used to type a special name for vane position 2.	POSITION 2
> Text for vanes Position 3	This parameter is used to type a special name for vane position 3.	POSITION 3
> Text for vanes Position 4	This parameter is used to type a special name for vane position 4	POSITION 4
> Text for vanes Position 5	This parameter is used to type a special name for vane position 5.	POSITION 5
> Text for vanes Position 6	This parameter is used to type a special name for vane position 6.	POSITION 6

3.7. Temperature

In this section, all of the parameters are corresponding to the setpoint temperature, AC unit ambient temperature. Some parameters of related objects and their tasks are described in this part.

GENERAL	Ac Unit Indoor Temperature Reference (Gateway must be master)	Indoor Temperature From Knx
LOGIC GATE		
CONVERTER	Sending of AC internal temperature	On change
OPERATING MODE	Sending of AC setpoint temperature	On change
FAN		
VANES	Setpoint control +/- object (1-bit)	1:Increase / 0:Decrease
TEMPERATURE	Limits for setpoint control	<input type="radio"/> Disabled <input checked="" type="radio"/> Enabled
SCENES	> Setpoint lower limit	16
SPECIAL	> Setpoint higher limit	30

Fig. 18 : Temperature Configuration Parameter Page

Ambient Temperature:

The air conditioner internal unit can display the temperature information via the "Feedback Indoor Temperature" object. However, it is also possible to receive the measurement of the measured ambient temperature from KNX by enabling the parameter "Indoor Temperature from KNX".

AC Unit Indoor Temperature Reference:

Temperature to be taken as the basis for air conditioning; Indoor Temperature sending disabled, Indoor Temperature from Knx, Indoor Unit Selects Optimum Temperature Sensor, can be selected.

Special Notes



The values of the air condition internal temperature and setpoint can be sent to the bus on change and/or periodically. By choosing periodically the period of sending can be defined from 1 to 255 seconds.

Setpoint Temperature:

Via the parameter “Limits for setpoint control” it is possible to enable a range for the setpoint to be modified. By enabling this option, the minimum and maximum set points available to send via KNX will be defined in the parameters “Setpoint lower limit” and “Setpoint higher limit”. By disabling this option, per default, the lower and higher limits will be limits of the air condition unit.

Via the object “Setpoint Temperature -/+” the setpoint temperature can be modified via a 1-bit object as follow:

- By sending “Up” (Value 0) or “Increase” (Value 1): The setpoint temperature will be increased by steps of 1°C until air condition unit limit or defined higher limit value.
- By sending “Down” (Value 1) or “Decrease” (Value 0): The setpoint temperature will be decreased by steps of 1°C until the air condition unit lower the limit value.

In the following figure, the Temperature configuration parameter page is shown.

3.7.1. Parameters List

PARAMETERS	DESCRIPTION	VALUES
AC Unit Indoor Temperature Reference	<p>Indoor temperature sending disabled: A/C return temperature selected.</p> <p>Indoor temperature from Knx: Temperature supplied from KNX.</p> <p>Indoor unit selects optimum temperature sensor: The air conditioner decides the choice between the average return temperature and the temperature supplied from the KNX bus.</p>	<p>Indoor Temperature Sending Disabled</p> <p>Indoor Temperature from Knx</p> <p>Indoor Unit Selects Optimum Temperature Sensor</p>
Sending of AC internal temperature	<p>This parameter enables the sending of internal temperature value information.</p> <p>Disabled: Temperature information is not sent. Periodically: Temperature information is sent periodically. On change: Temperature information is sent when there is a 1K change in the temperature value. Periodically and on change: Temperature information is sent periodically and this information is sent when there is a 0.5K change in the temperature value.</p>	<p>Disabled</p> <p>Periodically</p> <p>On change</p> <p>Periodically and on change</p>
> Period of sending (sec)	<p>This parameter sets the sending period of the internal temperature value in seconds.</p>	<p>1...255</p>
Sending of AC setpoint temperature	<p>This parameter enables the sending of internal temperature value information.</p> <p>Periodically: Temperature information is sent periodically. On change: Temperature information is sent when there is a 1K change in the temperature value. Periodically and on change: Temperature information is sent periodically and this information is sent when there is a 1K change in the temperature value.</p>	<p>Periodically</p> <p>On change</p> <p>Periodically and on change</p>

> Period of sending (sec)	This parameter sets the sending period of the setpoint temperature value in seconds.	1...255
Setpoint control +/- object (1-bit)	This parameter enables to change of the desired temperature value as +/- with the 1-bit object.	Disabled 1:Increase/0:Decrease 0:Up/1:down
Limits for setpoint control	This parameter enables limits for the setpoint temperature value.	Disabled Enabled
> Setpoint lower limit	This parameter activates a lower limit for the setpoint temperature value.	16... 18 ...30
> Setpoint higher limit	This parameter activates a higher limit for the setpoint temperature value.	16... 18 ...30

3.8. Scenes

On this parameter page, up to 5 different scenarios can be configured. Each scene functions are identical and the configuration of each scene permits:

- The number of scenes (Between 1-64) can be assigned.
- The air condition unit's on/off values can be set.
- The air condition unit's AC mode can be configured.
- Fan levels of the related scene can be specified.
- Vane positions of the related scene can be specified.
- The setpoint temperature can be set of the scene.
- The scene can be stored by enabling the storage function.
- Delay time can be specified for starting the scene.

GENERAL	SCENE 1	<input type="radio"/> Disabled <input checked="" type="radio"/> Enabled
LOGIC GATE	> Number	1
CONVERTER	> AC On/Off	On
OPERATING MODE	> AC Mode	Auto
FAN	> AC Fan level	Fan 1
VANES	> AC Vanes position	Pos 2
TEMPERATURE	> AC Setpoint temperature	Not Involved
SCENES	> Storage function	<input checked="" type="radio"/> Disabled <input type="radio"/> Enabled
SPECIAL	> Delay (sec)	0
	> Activation object (1-bit)	<input checked="" type="radio"/> Disabled <input type="radio"/> Enabled
	SCENE 2	<input checked="" type="radio"/> Disabled <input type="radio"/> Enabled
	SCENE 3	<input checked="" type="radio"/> Disabled <input type="radio"/> Enabled
	SCENE 4	<input checked="" type="radio"/> Disabled <input type="radio"/> Enabled
	SCENE 5	<input checked="" type="radio"/> Disabled <input type="radio"/> Enabled

Fig. 19 : Scenes Configuration Parameter Page

Via the object “Scene”, telegrams that contains the call or store functions of a scene are sent. Up to 1...64 scenario numbers can be selected for 5 scenarios via a single group address. The scenario number telegram must match the pre-configured scenario number in the parameters.

The scene number (1-64), is used to recall the scene via the corresponding object. For storage of the scene, the value sent via the object “Scene” must be 128+scene number. The recall of each scene can be delayed whether a time delay has been previously defined in the parameter window.

Special Notes



After ETS programming, the scene values parameterized for the output concerned will be overwritten into the gateway. It means that any change made by the user will be deleted. Therefore, it is important, before any maintenance, to know the previous scene configuration and whether the user wants to keep operating with that configuration.

3.8.1. Parameters List

PARAMETERS	DESCRIPTION	VALUES
Scene 1 . . Scene 5	This parameter is used to enable or disable the related scenario.	Disabled Enabled
> Number	This parameter is used to specify the scene number of the corresponding scene.	1...64
> AC On/Off	This parameter is used to determine the on/off status of the air condition unit for the selected scenario.	On Off Not Involved
> AC Mode	This parameter is used to specify the mode of the air condition unit for the selected scenario.	Auto Heat Cool Fan Dry Not Involved
> AC Fan level	This parameter is used to specify the fan level of the air condition unit for the selected scenario.	Fan 1 Fan 2 Fan 3 Fan Auto Not Involved
> AC Vanes position	This parameter is used to specify the vane positions of the air condition unit for the selected scenario.	Pos 1 Pos 2 Pos 3 Pos 4 Pos 5 Pos 6 Swing Not Involved
> AC Setpoint temperature	This parameter is used to specify the setpoint temperature of the selected scenario.	Not Involved 16°C...30°C

> Storage function	This parameter is used to save the selected scenario.	Disabled Enabled
> Delay (sec)	This parameter is used to set a delay time for starting the selected scene.	0...255
> Activation object (1-bit)	This parameter is used to enable or disable the activation object to activate the scenario.	Disabled Enabled

3.9. Special

In this section, special functionalities of the LG AC - KNX Gateway are described. The gateway has 4 different functions for special purposes. Each of them is explained in separate subtitles.

GENERAL	Working hours counter	<input type="radio"/> Disabled <input checked="" type="radio"/> Enabled
LOGIC GATE	> Setpoint for alert (hour)	1
CONVERTER	Enable window contact	0:Open / 1:Close
OPERATING MODE	> Switch-off time delay	<input checked="" type="radio"/> Via parameter <input type="radio"/> Via communication object
FAN	> Switch-off time delay (min)	0
VANES	> Reject On/Off actions if window is open	<input type="radio"/> Disabled <input checked="" type="radio"/> Enabled
TEMPERATURE	> Behavior after window is close	Scene 1
SCENES	Enable standby function	1:Occupied / 0:Not occupied
SPECIAL	> Standby function delay	<input checked="" type="radio"/> Via parameter <input type="radio"/> Via communication object
	> Standby function delay (min)	0
	> Behavior during standby function	Setpoint shifting
	> Setpoint shifting	<input checked="" type="radio"/> Via parameter <input type="radio"/> Via communication object
	> Setpoint shifting (°C)	1
	> Activate secondary standby action	<input type="radio"/> Disabled <input checked="" type="radio"/> Enabled
	> Secondary standby action delay	<input checked="" type="radio"/> Via parameter <input type="radio"/> Via communication object
	> Secondary standby action delay (min)	1
	> Behavior during secondary standby function	Setpoint shifting
	> Secondary setpoint shifting	<input checked="" type="radio"/> Via parameter <input type="radio"/> Via communication object
	> Secondary setpoint shifting (°C)	1
	> Reject modifications during standby function	<input type="radio"/> Disabled <input checked="" type="radio"/> Enabled
	> Behavior after standby function	No reaction - Last state
	Enable timer function	<input type="radio"/> Disabled <input checked="" type="radio"/> Enabled
	> Polarity	<input checked="" type="radio"/> 1:Start / 0:Stop <input type="radio"/> 0:Start / 1:Stop
	> Timer duration	<input checked="" type="radio"/> Via parameter <input type="radio"/> Via communication object
	> Timer duration (min)	1
	> Timer retriggerable	<input checked="" type="radio"/> No <input type="radio"/> Yes

Fig. 20 : Special Configuration Parameter Page

Working Hours Counter : This function is used to know the air conditioner's operating hour as "ON" position. When the "ON" status of the air condition unit is counted for one hour, the object value increases "1K". The counter is available to create an alert to warn the user after the desired time later. The counter can be reset via the "Reset Hours Counter" object.

Window Contact : This function is used for window contacts to determine the operation type when the window contacts are open or close. When the "window is open" information is received, it is possible to switch off the air condition unit or activate any predefined scene. However, it is possible to specify a delay time for the operation type to be started or to restrict the On / Off action of the air condition unit. After incoming "window contacts are closed" information, the behaviour of the air condition unit can be selected as one of the predefined scenarios, OFF or the previous state of this function.

Standby Function : This function is used to activate the standby modes for the air condition unit to determine the operation type for the standby modes. During standby function, it is possible to make setpoint shifting, activate any predefined scene or switch off the air condition unit. However, it is possible to specify delay time for operation type to be started or to reject modifications for the air condition unit during standby function. After incoming standby function stop information, the behaviour of the air condition unit can be selected as one of scenario, off or the previous state. Additionally, a secondary standby function is available and the same parameters and object are valid for the secondary standby function.

Timer Function : The timer function switches off the air condition unit after a defined time. Polarity and durations can be determined via sub-parameters of this function. The timer function is also retriggerable and when timer retrigger is enabled, the timer restarts itself for counting for switch off the air condition unit.

3.9.1. Parameters List

PARAMETERS	DESCRIPTION	VALUES
Working hours counter	This parameter is used to enable or disable the working hours counter function.	Disabled Enabled
> Setpoint for alert (hour)	This parameter is used to set a setpoint alarm point for the working hours counter of the air conditioner unit.	1...65535
Enable window contact	This parameter is used to enable or disable the air conditioner unit's window contact function.	Disabled 0:Open/1:Close 1:Open/0:Close
> Switch-off time delay	This parameter is used to specify the switch-off time delay that is sent via parameter or communication object.	Via parameter Via communication object
> Switch-off time delay (min)	This parameter is used to set delay time in minutes to switch off the air conditioner.	0...255
> Reject On/Off actions if window is open	This parameter is used to reject on & off actions of the air conditioner unit's when the window is opened.	Disabled Enabled
> Behaviour after window is close	This parameter is used to specify the behaviour after window is closed. For instance, one of the configured scenarios can be operated, the conditioner unit is turned off or the last state is maintained.	No reaction – Last state Off Scene 1 Scene 2 Scene 3 Scene 4 Scene 5
Enable standby function	This parameter is used to enable or disable the standby function. According to occupied or not occupied status, configurations can be made.	Disabled 1:Occupied/0:Not occupied 1:Start/0:Stop

> Standby function delay	This parameter is used to specify the standby function delay that is sent via parameter or communication object.	Via parameter Via communication object
> Standby function delay (min)	This parameter is used to set a delay time in minutes for the standby function.	0...255
> Behaviour during standby function	This parameter is used to configure the behaviour during the standby function. For instance, one of the configured scenarios can be operated, the conditioner unit is turned off or the last state is maintained.	Setpoint shifting Off Scene 1 Scene 2 Scene 3 Scene 4 Scene 5
> Setpoint shifting	This parameter is used to specify the setpoint shifting that is sent via parameter or communication object.	Via parameter Via communication object
> Setpoint shifting (°C)	This parameter is used to set the setpoint shifting temperature value.	1...4
> Activate secondary standby action	This parameter is used to enable or disable the secondary standby function.	Disabled Enabled
> Secondary standby action delay	This parameter is used to specify the secondary standby action delay that is sent via parameter or communication object.	Via parameter Via communication object
> Secondary standby action delay (min)	This parameter is used to specify the secondary standby action delay in minutes.	1...255
> Behaviour during secondary standby function	This parameter is used to configure the behaviour during the secondary standby function. For instance, one of the configured scenarios can be operated, the conditioner unit is turned off or the last state is maintained.	Setpoint shifting Off Scene 1 Scene 2 Scene 3 Scene 4 Scene 5
> Secondary setpoint shifting	This parameter is used to set the secondary setpoint shifting temperature value.	Via parameter Via communication object
> Secondary setpoint shifting (°C)	This parameter is used to set the secondary setpoint shifting temperature value.	1...4

> Reject modifications during standby function	This parameter is used to enable or disable the reject modifications during the standby function. If this parameter is enabled, no modifications can be allowed in standby mode.	Disabled Enabled
> Behaviour after standby function	This parameter is used to configure the behaviour during the standby function. For instance, one of the configured scenarios can be operated, the conditioner unit is turned off or the last state is maintained.	No reaction – Last state Off Scene 1 Scene 2 Scene 3 Scene 4 Scene 5
Enable timer function	This parameter is used to enable or disable the timer function.	Disabled Enabled
> Polarity	This parameter is used to specify the polarity of enabling command the timer function.	1:Start/0:Stop 0:Start/1:Stop
> Timer duration	This parameter is used to specify the timer duration that is sent via parameter or communication object.	Via parameter Via communication object
> Timer duration (min)	This parameter is used to set delay time in minutes for the timer function.	1...65535
> Timer retriggerable	This parameter is used to restart the timer.	No Yes

4. ETS Objects List & Descriptions

The Interra LG AC - KNX Gateway can communicate via the KNX bus line. In this section, the group objects of the Interra LG Gateway are described.

ETS group objects are divided into 10 main parts, and these are :

- ❖ **General** - General group objects to the LG Gateway.
- ❖ **Logic Gate** - These objects are related to logic gate parameters.
- ❖ **Converter** - These objects are related to converter parameters.
- ❖ **Operating Mode** - These objects are related to operating mode parameters.
- ❖ **Fan** - These objects are related to fan parameters.
- ❖ **Vanes** - These objects are related to vanes parameters.
- ❖ **Temperature** - These objects are related to temperature parameters.
- ❖ **Scenes** - These objects are related to scenes parameters.
- ❖ **Special** - These objects are related to special functions.

Special Note



Due to the flexible ETS configurations feature, some group objects are dynamic and they are only visible if the related parameters are activated in the application program.

All of the group objects of Interra LG AC - KNX Gateway are listed below. You can quickly browse through this table to get the functional capabilities of Interra LG Gateway.

The detailed functions of group objects are described in different topics.

4.1. General Objects

This section describes the "general" group objects and their properties. General group objects, as the name suggests, indicate the general characteristics of the LG Gateway.

Object Name	Function	Type	Flags
Alive Beacon	1:True/0:False	1 bit	CRT
<p>This object is used to monitor the presence of the device on the KNX bus line regularly. However, monitoring telegrams can be sent cyclically on the KNX bus line. This object has appeared only the "Module Alive Beacon" parameter is enabled.</p>			
Climate On/Off	1:On/0:Off	1 bit	CWT
<p>This object is used to turn the Gateway on or off. Also, this object is visible permanently. If you associate the desired group address, Gateway can be controlled with On and Off.</p>			
Feedback Climate On/Off	1:On/0:Off	1 bit	CRT
<p>This object is used to check the status of the air conditioner unit. Also, this object is visible permanently. If you associate the desired group address, Gateway's ON and OFF status can be monitored.</p>			
Setpoint Temperature	Temperature (Celsius)	2 bytes	CWT
<p>This object is used to set the air conditioner unit's temperature. Also, this object is visible permanently. The temperature can be set to the desired value and then the air conditioner works according to this value.</p>			
Feedback Setpoint Temperature	Temperature (Celsius)	2 bytes	CRT
<p>This object is used to check the status of the air conditioner's setpoint temperature. Also, this object is visible permanently. If you associate the desired group address, Gateway's setpoint temperature can be monitored.</p>			
Feedback Indoor Temperature	Temperature (Celsius)	2 bytes	CRT
<p>This object is used to check the status of the air conditioner unit's indoor temperature. Also, this object is visible permanently. If you associate the desired group address, Gateway's indoor temperature can be monitored.</p>			
Feedback Error Alarm	1:Alarm/0:No Alarm	1 bit	CRT
<p>This object is used to check the status of the air conditioner unit's error alarm. Also, this object is visible permanently. If there is an error alarm and a group address is associated with the corresponding object, the alarm can be monitored.</p>			
Feedback Error Code	Error Code Information	2 bytes	CRT
<p>This object is used to give information about the error codes. This functionality allows sending messages to the KNX bus informing about errors. Errors management handles air conditioner unit error codes as well as any communication errors that may arise. For more detailed information check the section APPENDIX.</p>			
Device Control Locking	1:Enabled / 0:Disabled 0:Enabled / 1:Disabled	1 bit	CRT

This object is used to lock the gateway device. When a “1” value is sent to this communication object, the gateway is locked. If a value is sent to the gateway via its communication objects, all values are ignored. For unlocking the gateway, a “0” value must be sent.

4.2. Logic Gate Objects

This section describes the "Logic Gate" group objects and their properties. Logic Gate group objects, as the name suggests, indicate the logical operations that can be made with LG Gateway.

Object Name	Function	Type	Flags
Logic 1	Input 1 – Logic Input Input 2 – Logic Input Input 3 – Logic Input Input 4 – Logic Input	1 bit	CRWT

This object is used to set the inputs of the logical gate to be used. Logical associations can be made over 1-bit values. The result is obtained according to the type of logical gate selected.

Logic 1	Output – Logic Output	1 bit	CRT
---------	-----------------------	-------	-----

This object is used to obtain the result of the logical gate to be used. The output value of the logical gate is 1 bit. The result is obtained according to the type of logical gate selected.

Special Notes



This is a fully compatible KNX device that must be configured and setup using the standard KNX tool ETS. Up to 4 different logic gates can be selected. Each logic gate can be set independently.

4.3. Converter Objects

This section describes the "Converter" group objects and their properties. Converter group objects are used to make mathematical operations and data converting from different types. Up to 8 different converters can be configured.

Object Name	Function	Type	Flags
Converter 1	Input (1-Bit) – Converter Input	1 bit	CRWT
	Input (2-Bit) – Converter Input	2 bits	
	Input (1-Byte) – Converter Input	1 byte	
	Input (2-Byte) – Converter Input	2 bytes	

This object is used to set the converter inputs to be used. The conversion processes can be made via 1 bit, 2bit, 1 byte and 2-byte values. The result is obtained according to the input type of the selected converter.

Converter 1	Input (1-Bit) – Converter Output	1 bit	CRWT
	Input (2-Bit) – Converter Output	2 bits	
	Input (1-Byte) – Converter Output	1 byte	
	Input (2-Byte) – Converter Output	2 bytes	

This object is used to obtain the result of the converter to be used. The output value of the converter can be 1 bit, 2-bit, 1 byte and 2 bytes. The result is obtained according to the configuration of the selected converter.

4.4. Operating Mode Objects

This section describes the "Operating Mode" group objects and their properties. Heat, cool, dry, auto and fan mode communication objects are described. Also, simple heating-cooling mode and summer, winter, energy saver and power saver mode objects are clarified.

Object Name	Function	Type	Flags
Operating Mode	0:Aut/1:Hea/3:Coo/9:Fan/14:Dry	1 byte	CWT

This object is used to set the operating modes of the air conditioner. You can select AUTO with 0, HEAT with 1, COOL with 3, FAN with 9, and DRY with 14.

Feedback Operating Mode	0:Aut/1:Hea/3:Coo/9:Fan/14:Dry	1 byte	CRT
-------------------------	--------------------------------	--------	-----

This object is used to monitor the status of the operating modes of the air conditioner. With value 0 the status is AUTO, with value 1 the status is HEAT, with value 3 status is COOL, with value 9 the status is FAN and with value 14 the status is DRY can be understood.

Operating Mode Heat/Cool	1:Heat/0:Cool 0:Heat/1:Cool	1 bit	CWT
--------------------------	--------------------------------	-------	-----

This object is used to set the operating mode of the air conditioner unit. When selecting this option, the related 1-bit object will be enabled. It allows establishing the desired mode: Cool mode, writing the value "0" in the object and Heat mode, writing the value "1" or vice versa.

Feedback Operating Mode Heat/Cool	1:Heat/0:Cool 0:Heat/1:Cool	1 bit	CRT
-----------------------------------	--------------------------------	-------	-----

This object is used to check the operating mode of the air conditioner unit.

Heating Mode Percent Value	0%:Off/1%-100%:On+Heat	1 byte	CWT
----------------------------	------------------------	--------	-----

This object is used to change operating mode to heat via incoming percentage value. It also provides compatibility with KNX thermostats that control the demand for heating or cooling by using percentage values. In these thermostats, the percentage demand is meant to be applied on a fluid valve of the heating/cooling system. If a non-zero value is received (>0%) the indoor unit will switch on to Heat mode.

Cooling Mode Percent Value	0%:Off/1%-100%:On+Cool	1 byte	CWT
----------------------------	------------------------	--------	-----

This object is used to change operating mode to cool via incoming percentage value. It also provides compatibility with KNX thermostats that control the demand for heating or cooling by using percentage values. In these thermostats, the percentage demand is meant to be applied on a fluid valve of the heating/cooling system. If a non-zero value is received (>0%) the indoor unit will switch on to Cool mode.

Individual Mode Auto	1:Set Mode Auto/0:Nothing	1 bit	CWT
----------------------	---------------------------	-------	-----

This object is used to change the air conditioner's operating mode to auto mode via a 1-bit object individually. If the value 1 is sent over the 1-bit value, the air conditioning unit will switch to automatic mode.

Feedback Individual Mode Auto	1:Auto	1 bit	CRT
This object is used to monitor the air condition unit status individually. If value 1 is received from this object, the operating mode is auto.			
Individual Mode Heat	1:Set Mode Heat/0:Nothing	1 bit	CWT
This object is used to change the air conditioner's operating mode to heat mode via a 1-bit object individually. If the value 1 is sent over the 1-bit value, the air conditioning unit will switch to heat mode.			
Feedback Individual Mode Heat	1:Heat	1 bit	CRT
This object is used to monitor the air condition unit status individually. If value 1 is received from this object, the operating mode is heating.			
Individual Mode Cool	1:Set Mode Cool/0:Nothing	1 bit	CWT
This object is used to change the air conditioner's operating mode to cool mode via a 1-bit object individually. If the value 1 is sent over the 1-bit value, the air conditioning unit will switch to cool mode.			
Feedback Individual Mode Cool	1:Cool	1 bit	CRT
This object is used to monitor the air condition unit status individually. If value 1 is received from this object, the operating mode is cool.			
Individual Mode Fan	1:Set Mode Heat/0:Nothing	1 bit	CWT
This object is used to change the air conditioner's operating mode to fan mode via a 1-bit object individually. If the value 1 is sent over the 1-bit value, the air conditioning unit will switch to fan mode.			
Feedback Individual Mode Fan	1:Fan	1 bit	CRT
This object is used to monitor the air condition unit status individually. If value 1 is received from this object, the operating mode is the fan.			
Individual Mode Dry	1:Set Mode Dry/0:Nothing	1 bit	CWT
This object is used to change the air conditioner's operating mode to dry mode via a 1-bit object individually. If the value 1 is sent over the 1-bit value, the air conditioning unit will switch to dry mode.			
Feedback Individual Mode Dry	1:Dry	1 bit	CRT
This object is used to monitor the air condition unit status individually. If value 1 is received from this object, the operating mode is dry.			
Operating Mode +/-	1:Increase/0:Decrease	1 bit	CWT
This object changes between operating modes as +/- via 1-bit value. This object is used to switch between the operating modes of the air conditioning unit in a loop. If a continuous value is sent in the increasing direction, it follows the following sequence and returns to the beginning when reaches the last mode.			

1:Increase : auto->heat->cool->fan->dry

0:Decrease : dry -> fan -> cool -> heat -> auto

Operating Mode +/-	0:Up/1:Down	1 bit	CWT
--------------------	-------------	-------	-----

This object changes between operating modes as +/- via 1-bit value. This object is used to switch between the operating modes of the air conditioning unit in a loop. If a continuous value is sent in the increasing direction, it follows the following sequence and returns to the beginning when reaches the last mode.

0:Up : auto->heat->cool->fan->dry

1:Down : dry -> fan -> cool -> heat -> auto

Feedback Operating Mode Text	Operating Mode Text	14 bytes	CRT
------------------------------	---------------------	----------	-----

This object is used to monitor the operation mode of the air conditioning unit in text format via the KNX bus line. Naming can be made for each operating mode with a length of 14 bytes.

Energy Saver Mode	1:Start/0:Stop	1 bit	CWT
-------------------	----------------	-------	-----

This object is used to initiate energy saver mode. If a value of 1 is sent over this object, energy mode starts, and a value of 0 stops.

Feedback Energy Saver Mode	1:Start/0:Stop	1 bit	CWT
----------------------------	----------------	-------	-----

This object is used to determine if the air conditioner unit is in energy saver mode.

Energy Saver Mode Time Duration	0-255 min	1 byte	CWT
---------------------------------	-----------	--------	-----

This object is used to determine how long the air conditioner unit stays in energy saver mode. Up to 255 minutes can be set with a 1-byte value.

Energy Saver Mode Setpoint Shifting	Temperature (Celsius)	2 bytes	CWT
-------------------------------------	-----------------------	---------	-----

This object is used to determine the shifting value for making a setpoint temperature setting. The values between 1-4 can be selected for shifting.

Energy Save Mode Fan Speed	1:Fan1/2:Fan2/3:Fan3	1 byte	CWT
----------------------------	----------------------	--------	-----

This object is used to determine the fan speed for energy saver mode. A value of 1 for fan speed 1, 2 for fan speed 2, and 3 for fan speed 3 must be sent.

Power Saver Mode	1:Start/0:Stop	1 bit	CWT
------------------	----------------	-------	-----

This object is used to initiate power saver mode. If a value of 1 is sent over this object, power mode starts, and a value of 0 stops.

Feedback Power Saver Mode	1:Start/0:Stop	1 bit	CWT
---------------------------	----------------	-------	-----

This object is used to determine if the air conditioner unit is in power saver mode.

Power Saver Time Duration	0-255 min	1 byte	CWT
This object is used to determine how long the air conditioner unit stays in power saver mode. Up to 255 minutes can be set with a 1-byte value.			
Power Saver Mode Setpoint Shifting	Temperature (Celsius)	2 bytes	CWT
This object is used to determine the shifting value for making setpoint temperature settings of power saver mode. The values between 1-4 can be selected for shifting.			
Power Saver Mode Fan Speed	1:Fan1/2:Fan2/3:Fan3	1 byte	CWT
This object is used to determine the fan speed for power saver mode. A value of 1 for fan speed 1, 2 for fan speed 2, and 3 for fan speed 3 must be sent.			
Winter Mode	1:Start/0:Stop	1 bit	CWT
This object is used to initiate winter mode. If a value of 1 is sent over this object, winter mode starts, and a value of 0 stops.			
Feedback Winter Mode	1:Start/0:Stop	1 bit	CWT
This object is used to determine if the air conditioner unit is in winter mode.			
Winter Mode Time Duration	0-255 min	1 byte	CWT
This object is used to determine how long the air conditioner unit stays in winter mode. Up to 255 minutes can be set with a 1-byte value.			
Winter Mode Setpoint Shifting	Temperature (Celsius)	2 bytes	CWT
This object is used to determine the shifting value for making setpoint temperature settings of winter mode. The values between 1-4 can be selected for shifting.			
Winter Mode Fan Speed	1:Fan1/2:Fan2/3:Fan3	1 byte	CWT
This object is used to determine the fan speed for winter mode. A value of 1 for fan speed 1, 2 for fan speed 2, and 3 for fan speed 3 must be sent.			
Summer Mode	1:Start/0:Stop	1 bit	CWT
This object is used to initiate summer mode. If a value of 1 is sent over this object, summer mode starts, and a value of 0 stops.			
Feedback Summer Mode	1:Start/0:Stop	1 bit	CWT
This object is used to determine if the air conditioner unit is in summer mode.			
Summer Mode Time Duration	0-255 min	1 byte	CWT
This object is used to determine how long the air conditioner unit stays in summer mode. Up to 255 minutes can be set with a 1-byte value.			

Summer Mode Setpoint Shifting	Temperature (Celsius)	2 bytes	CWT
-------------------------------	-----------------------	---------	-----

This object is used to determine the shifting value for making setpoint temperature settings of summer mode. The values between 1-4 can be selected for shifting.

Summer Mode Fan Speed	1:Fan1/2:Fan2/3:Fan3	1 byte	CWT
-----------------------	----------------------	--------	-----

This object is used to determine the fan speed for summer mode. A value of 1 for fan speed 1, 2 for fan speed 2, and 3 for fan speed 3 must be sent.

4.5. Fan Group Objects

In this section, fan group objects and their properties are described.

Object Name	Function	Type	Flags
Fan Speed Percent	Threshold defined in parameter	1 byte	CWT
<p>This object is used to set fan speeds in percentages. 3 different fan speeds can be configured according to the specified threshold values. For example, select Fan 1 lower limit is 30% and fan 2 lower limit is 55%. If a 25% value is sent over this object, fan speed will be fan1, if 45% value is sent, fan speed will be fan2.</p>			
Fan Speed Enumerated	0:Auto...3:Speed3	1 byte	CWT
<p>This object is used to determine the fan speed by selecting between 1-3 values. For example, if value 1 is sent, fan speed will be fan 1.</p>			
Feedback Fan Speed Enumerated	0:Auto...3:Speed3	1 byte	CRT
<p>This object is used to receive current fan speed in between 1-3 values.</p>			
Fan Speed Auto/Manual	1:Auto/0:Manual	1 bit	CWT
<p>This object is used to determine the fan speed control with auto or manual mode. If value 1 is sent, the auto mode will be activated. On contrary, if value 0 is sent, the manual mode will be activated.</p>			
Feedback Fan Speed Auto/Manual	1:Auto/0:Manual	1 bit	CRT
<p>This object is used to receive the current fan speed status of the air conditioner unit as auto or manual.</p>			
Individual Fan Speed 1	1:Set Fan Speed 1/0:Nothing	1 bit	CWT
<p>This object is used to select fan speed 1 individually. If a value 1 is sent, the fan speed will be fan 1.</p>			
Individual Fan Speed 2	1:Set Fan Speed 2/0:Nothing	1 bit	CWT
<p>This object is used to select fan speed 2 individually. If a value 1 is sent, the fan speed will be fan 2.</p>			
Individual Fan Speed 3	1:Set Fan Speed 3/0:Nothing	1 bit	CWT
<p>This object is used to select fan speed 3 by individually. If a value 1 is sent, the fan speed will be fan 3.</p>			
Feedback Individual Fan Speed 1	1:Fan Speed 1	1 bit	CRT
<p>This object is used to monitor the fan speed 1 of the air conditioner.</p>			
Feedback Individual Fan Speed 2	1:Fan Speed 2	1 bit	CRT

This object is used to monitor the fan speed 2 of the air conditioner.

Feedback Individual Fan Speed 3	1:Fan Speed 3	1 bit	CRT
---------------------------------	---------------	-------	-----

This object is used to monitor the fan speed 3 of the air conditioner.

Fan Speed +/-	1:Increase/0:Decrease	1 bit	CWT
---------------	-----------------------	-------	-----

This object is used to change between fan speed levels with a 1-bit value. If a continuous value is sent in the increasing direction, it follows the following sequence. Additionally, if the “Loop the sequence” parameter is activated, increasing or decreasing that returns the mode to the beginning when it reaches the last mode.

1:Increase : auto->fan speed 1->fan speed 2->fan speed 3

0:Decrease : Fan speed 3->fan speed 2->fan speed 1->auto

Fan Speed +/-	0:Up/1:Down	1 bit	CWT
---------------	-------------	-------	-----

This object is used to change between fan speed levels with a 1-bit value. If a continuous value is sent in the increasing direction, it follows the following sequence. Additionally, if the “Loop the sequence” parameter is activated, increasing or decreasing that returns the mode to the beginning when it reaches the last mode.

1:Up : auto->fan speed 1->fan speed 2->fan speed 3

0:Down : Fan speed 3->fan speed 2->fan speed 1->auto

Feedback Fan Speed Text	Fan Speed Text	14 bytes	CRT
-------------------------	----------------	----------	-----

This object is used to receive the air conditioner unit's fan speed status via text format. For each fan speed status(auto, fan speed1, fan speed2, fan speed3) up to 14 bytes are allowed to determine the name of the fan speeds.

4.6. Vanes Group Objects

In this section, vane group objects and their properties are described.

Object Name	Function	Type	Flags
Vane Position Percent	Threshold defined in parameter	1 byte	CWT

This object is used to set vane positions in percentages. At least 4 different fan speeds can be configured according to the specified threshold values. For example, select vane position 1 lower limit is 24% and vane position 2 lower limit is 48%. If a 15% value is sent over this object, the vane position will be position 1, if 39% value is sent, the vane position will be position 2.

Vane Position Enumerated	1:Pos1...6:Pos6	1 byte	CWT
--------------------------	-----------------	--------	-----

This object is used to determine the vane position by selecting between 1-4 or 1-5 values. For example, available vane positions are 5 and if value 3 is sent, the vane position will be position 3.

Feedback Vane Position Enumerated	1:Pos1...6:Pos6	1 byte	CRT
-----------------------------------	-----------------	--------	-----

This object is used to receive the current vane position in between 1-6 values.

Vane Set Position 1	1:Set Position 1/0:Nothing	1 bit	CWT
---------------------	----------------------------	-------	-----

This object is used to select vane position 1 individually. If a value 1 is sent, the vane position will be position 1.

Vane Set Position 2	1:Set Position 2/0:Nothing	1 bit	CWT
---------------------	----------------------------	-------	-----

This object is used to select vane position 2 individually. If a value 1 is sent, the vane position will be position 2.

Vane Set Position 3	1:Set Position 3/0:Nothing	1 bit	CWT
---------------------	----------------------------	-------	-----

This object is used to select vane position 3 by individually. If a value 1 is sent, the vane position will be position 3.

Vane Set Position 4	1:Set Position 4/0:Nothing	1 bit	CWT
---------------------	----------------------------	-------	-----

This object is used to select vane position 4 individually. If a value 1 is sent, the vane position will be position 4.

Vane Set Position 5	1:Set Position 5/0:Nothing	1 bit	CWT
---------------------	----------------------------	-------	-----

This object is used to select vane position 5 individually. If a value 1 is sent, the vane position will be position 5.

Vane Set Position 6	1:Set Position 6/0:Nothing	1 bit	CWT
---------------------	----------------------------	-------	-----

This object is used to select vane position 6 by individually. If a value 1 is sent, the vane position will be position 6.

Feedback Vanes Set Position 1	1:Position 1	1 bit	CRT
-------------------------------	--------------	-------	-----

This object is used to monitor the vane position 1 of the air conditioner.

Feedback Vanes Set Position 2	1:Position 2	1 bit	CRT
-------------------------------	--------------	-------	-----

This object is used to monitor the vane position 2 of the air conditioner.

Feedback Vanes Set Position 3	1:Position 3	1 bit	CRT
-------------------------------	--------------	-------	-----

This object is used to monitor the vane position 3 of the air conditioner.

Feedback Vanes Set Position 4	1:Position 4	1 bit	CRT
-------------------------------	--------------	-------	-----

This object is used to monitor the vane position 4 of the air conditioner.

Feedback Vanes Set Position 5	1:Position 5	1 bit	CRT
-------------------------------	--------------	-------	-----

This object is used to monitor the vane position 5 of the air conditioner.

Feedback Vanes Set Position 6	1:Position 6	1 bit	CRT
-------------------------------	--------------	-------	-----

This object is used to monitor the vane position 6 of the air conditioner.

Vanes Set Swing	1:Swing/0:Off	1 bit	CWT
-----------------	---------------	-------	-----

This object is used to enable the swing function for the vanes. If a value 1 is sent, the vanes will start swinging. After vanes started swinging, if value 0 is sent, the vanes will stop the swinging.

Feedback Vanes Swing	1:Swing/0:Off	1 bit	CWT
----------------------	---------------	-------	-----

This object is used to receive information about the vanes are swinging or not.

Vane Position +/-	1:Increase/0:Decrease	1 bit	CWT
-------------------	-----------------------	-------	-----

This object is used to change between vane position levels with a 1-bit value. If a continuous value is sent in the increasing direction, it follows the following sequence. Additionally, if the “Loop the sequence” parameter is activated, increasing or decreasing that returns the mode to the beginning when it reaches the last mode.

1:Increase : pos 1->pos 2->pos 3->pos 4->pos 5->pos 6->SWING

0:Decrease : SWING->pos 6->pos 5->pos 4->pos 3->pos 2->pos 1

Vane Position +/-	0:Up/1:Down	1 bit	CWT
-------------------	-------------	-------	-----

This object is used to change between vane position levels with a 1-bit value. If a continuous value is sent in the increasing direction, it follows the following sequence. Additionally, if the “Loop the sequence” parameter is activated, increasing or decreasing that returns the mode to the beginning when it reaches the last mode.

0:Up : pos 1->pos 2->pos 3->pos 4->pos 5->pos 6->SWING

1:Down : SWING->pos 6->pos 5->pos 4->pos 3->pos 2->pos 1

Feedback Vanes Position Text	Vanes Position Text	14 bytes	CRT
------------------------------	---------------------	----------	-----

This object is used to receive the air conditioner unit's van position status via text format. For each vane position status (auto, pos1, pos2, pos3, pos4, pos5, pos6, SWING) up to 14 bytes are allowed to determine the name of the vane positions.

4.7. Temperature Group Objects

In this section, temperature group objects and their properties are described.

Object Name	Function	Type	Flags
Setpoint Temperature	Temperature(Celsius)	2 bytes	CWT

This object is used to modify the setpoint temperature to be sent to the AC indoor unit according to the desired value.

Feedback Setpoint Temperature	Temperature(Celsius)	2 bytes	CRT
-------------------------------	----------------------	---------	-----

This object is used to monitor the air conditioner unit setpoint temperature from the KNX bus line.

Setpoint Temperature +/-	1:Increase/0:Decrease	1 bit	CWT
--------------------------	-----------------------	-------	-----

This object is used to change the setpoint temperature by increasing or decreasing by a 1-bit value. If a continuous value is sent in the increasing direction, it is increased up to the highest temperature value. Likewise, if a continuous value is sent in the decreasing direction, it is decreased up to the lowest temperature value.

Setpoint Temperature +/-	0:Up/1:Down	2 bytes	CWT
--------------------------	-------------	---------	-----

This object is used to change the setpoint temperature by increasing or decreasing by a 1-bit value. If a continuous value is sent in the increasing direction, it is increased up to the highest temperature value. Likewise, if a continuous value is sent in the decreasing direction, it is decreased up to the lowest temperature value.

KNX Ambient Temperature	Temperature (Celsius)	2 bytes	CRWT
-------------------------	-----------------------	---------	------

This object is used to receive the KNX ambient temperature from the KNX bus line. This option only works when the LG Gateway operates in master mode.

Feedback Indoor Temperature	Temperature (Celsius)	2 bytes	CRT
-----------------------------	-----------------------	---------	-----

This object is used to read the indoor temperature from the air conditioner internal unit.

4.8. Scene Group Objects

In this section, scene group objects and their properties are described.

Object Name	Function	Type	Flags
Scene	1-64:Run/128+Scene:Storage	1 byte	CWT

This object is used to execute or store a scenario with a specified scenario number. According to the KNX scenario numbers could be between 1-64. If a scenario wanted to be stored, the scenario number + 128 value must be sent. Also, this object is always visible.

Scene 1...5 Run	1:Run Scene/0:Nothing	1 bit	CWT
-----------------	-----------------------	-------	-----

This object is used to run the associated scenario number 1 to 5. These scenario numbers are listed on the scene parameter page.

Scene 1...5 Storage	1:Storage Scene/0:Nothing	1 bit	CWT
---------------------	---------------------------	-------	-----

This object is used to record the current status of the air conditioner unit to the desired scenario from 1 to 5. The desired scenario number (e.g., 68) can be assigned to these scenes.

Feedback Current Scene	1-64:Current Scene	1 byte	CRT
------------------------	--------------------	--------	-----

This object is used to view the current scene of the air conditioner unit. Scene values can be monitored from the KNX bus line. According to KNX standards scene values should be between 1-64.

4.9. Special Group Objects

In this section, special functions group objects and their properties are described.

Object Name	Function	Type	Flags
Feedback Working Hours Counter	Working Hours Counter	2 bytes	CRT

This object is used to detect the air conditioner's operating hours in working mode. When the air conditioner starts to work, the working hours counter starts to count the value.

Feedback Working Hours Alert	1:Alarm/0:No Alarm	1 bit	CRT
------------------------------	--------------------	-------	-----

This object is used to view the air conditioner unit's alert status when the specified working hours operation period ends. Counter creates an alert to warn the user.

Reset Hours Counter	1:Reset/0:Nothing	1 bit	CWT
---------------------	-------------------	-------	-----

This object is used to reset the counted hours by the working hours counter function. If a value 1 is sent via this object, the working hours counter will be reset.

Window Contact Status	0:Open/1:Close 1:Open/0:Close	1 bit	CRWT
-----------------------	----------------------------------	-------	------

This object is used to receive the status of the window contact. It can be configured which value to which it means from the parameter page.

Window Switch-Off Delay	0-255 min	1 byte	CWT
-------------------------	-----------	--------	-----

This object is used to switch off the air condition unit according to delay time in minutes by a 1-byte value.

Standby Function	1:Occupied/0:Not Occupied 1:Start/0:Stop	1 bit	CWT
------------------	---	-------	-----

This object is used to control the standby function of the air conditioner unit. The object also can be parameterized as start/stop or occupied/not occupied.

Feedback Standby Function	1:Occupied/0:Not Occupied 1:Start/0:Stop	1 bit	CRT
---------------------------	---	-------	-----

This object is used to view the air condition unit's standby function status.

Standby Function Delay	0-255 min	1 byte	CWT
------------------------	-----------	--------	-----

This object is used to set the delay time of the air conditioner unit's standby function.

Standby Function Setpoint Shifting	Temperature (Celsius)	2 bytes	CWT
------------------------------------	-----------------------	---------	-----

This object is used to set the setpoint shifting of the air conditioner unit's standby function.

Standby Function Secondary Delay	0-255 min	1 byte	CWT
----------------------------------	-----------	--------	-----

This object is used to set the delay time of the air conditioner unit's secondary standby function.

Standby Function Secondary Setpoint Shifting	Temperature (Celsius)	2 bytes	CWT
--	-----------------------	---------	-----

This object is used to set the setpoint shifting of the air conditioner unit's secondary standby function.

Timer Function	1:Start/0:Stop 0:Start/1:Stop	1 bit	CWT
----------------	----------------------------------	-------	-----

This object is used to control the timer function of the air conditioner unit. The start and stop operations can be determined with which value will be used. Value 1 can be start function or stop according to settings.

Feedback Timer Function	1:Start/0:Stop 0:Start/1:Stop	1 bit	CRT
-------------------------	----------------------------------	-------	-----

This object is used to view the timer function status of the air conditioner unit.

Timer Duration	1-65535 min	2 bytes	CWT
----------------	-------------	---------	-----

This object is used to specify the time duration of the timer function. From 1 to 65535 min can be used as a duration value.

Appendix

Error Code KNX	Error Code in Remote Controller Unit	Error Definition
1	1	Room air sensor fault
2	2	Indoor unit pipe in sensor fault
3	3	Communication fault between the wired remote controller and indoor unit
4	4	Drain pump fault
5	5	Communication fault between indoor unit and outdoor unit
6	6	Indoor unit pipe out sensor fault
7	7	Indoor unit mode runs on opposite to outdoor unit
8	8	N/A
9	9	EEPROM memory fault
10	10	BLDC motor signal fault or motor lock
11	11	HEX middle point sensor fault
12	12	Heater terminal block sensor fault
13	13	N/A
14	14	N/A
15	15	N/A
16	16	N/A
17	17	Outlet air sensor fault
18	18	Return air sensor fault
19	19	No communication response from sub-PCB to main PCB
20	20	No communication response from main PCB to sub-PCB
21	21	IPM fault
22	22	AC input is over current (RMS)
23	23	DC link low or high voltage
24	24	High pressure or low pressure switch on
25	25	High/low input voltage

26	26	Compressor start failure
27	27	PSC/PFC fault
28	28	DC link high voltage
29	29	Overcurrent at compressor input
32	32	Discharge temperature is high at inverter compressor
33	33	Discharge temperature is high at constant speed compressor
34	34	High pressure is too high
35	35	Low pressure is too low
36	36	The compression ratio is too low
39	39	Communication fault between PFC and inverter PCB
40	40	CT sensor fault
41	41	Discharge sensor at inverter compressor is the fault
42	42	The low-pressure sensor is the fault
43	43	The high-pressure sensor is the fault
44	44	Air sensor at outdoor unit is the fault
45	45	HEX sensor at outdoor unit is the fault
46	46	Compressor suction sensor is the fault
47	47	Discharge sensor at constant speed compressor is the fault
48	48	HEX outlet sensor at outdoor unit is the fault
49	49	IPM temperature sensor is the fault
50	50	Missing phase among 3 phase
51	51	Over combination ratio
52	52	No communication from inverter PCB detected at main PCB
53	53	Communication fault between indoor and outdoor unit
54	54	The reverse-phase is detected
57	57	No communication from main PCB detected at inverter PCB
59	59	Wrong outdoor unit combination
60	60	Inverter EEPROM memory fault
61	61	Outdoor pipe temperature is too high
62	62	IPM temperature is too high

65	65	IPM temperature sensor is the fault
67	67	Fan locked or fan start failure
69	69	CT sensor of constant speed compressor 1 is the fault
70	70	CT sensor of constant speed compressor 2 is the fault
71	71	PFC CT sensor fault
72	72	Function error of outdoor 4way valve. (reversing valve)
73	73	DC peak current is over
74	74	Unbalance at 3 phase
75	75	Fan CT sensor fault
76	76	Fan DC link voltage is high
77	77	Fan input voltage is high
78	78	Fan hall sensor fault
79	79	Fan motor start failure
86	86	Main PCB EEPROM is fault
87	87	Fan PCB EEPROM is fault
88	88	PFC PCB EEPROM is fault
90	90	Inlet temperature sensor of external PCB is fault
91	91	The outlet temperature sensor of the external PCB is the fault
104	104	No Communication from the slave is detected
105	105	Communication fault between fan and inverter PCB
106	106	Fan PCB IOM fault
107	107	Fan DC link voltage is low
113	113	Liquid pipe sensor fault
114	114	Subcooling inlet pipe sensor fault
115	115	Subcooling outlet pipe sensor fault
116	116	Oil level sensor fault
145	145	No communication from external PCB is detected at the main PCB
151	151	4-way valve failure
153	153	Upper HEX sensor fault
154	154	Bottom HEX sensor fault

173	173	Over / low current at constant speed compressor 1
174	174	Over / low current at constant speed compressor 2
182	182	Communication fault between main and sub micom in external PCB
187	187	Hydrokit water temperature sensor fault
190	190	Inverter PCB heat sink temperature is high
191	191	Inverter PCB heat sink temperature sensor fault
193	193	Fan PCB heat sink temperature is high
194	194	Fan PCB heat sink temperature sensor fault
200	200	Auto piping failure
201	201	Fault at liquid pipe sensor of HR unit
202	202	Fault at subcooling inlet pipe sensor of HR unit
203	203	Fault at subcooling outlet pipe sensor of HR unit
204	204	No communication from the outdoor unit is detected at the HR unit
205	205	HR unit addresses are duplicated
237	237	No response from the outdoor unit modem at the indoor unit modem
238	238	No response from the outdoor unit at the outdoor unit modem

Special Notes



If you encounter an error code not listed in this table, please contact your nearest LG technical service.

CONTACT INFORMATION

THE INTERRA WEBSITE

Interra provides documentation support via our web site www.interratechnology.com. This website is used as a means to make files and information easily available to customers. Accessible by using your favourite Internet browser, the website contains the following information:

- Information about our products and projects.
- Overview of Interra company and values.
- Product Support: Datasheets, product manuals, application descriptions, latest software releases, ETS databases and archived software.

EUROPE, Turkey

Interra

Cumhuriyet Mah. Kartal Cad. Simkan Plaza No:95/1
Kartal/İstanbul

Tel: +90 (216) 326 26 40 Fax: +90 (216) 324 25 03

Web adress: <http://www.interratechnology.com>