

Unpacking

Before you begin using the device, please check the version you got and ensure that the following items are included in the shipped box:

Mainframe Accessories:

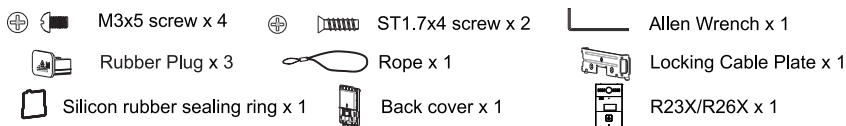

Wall mounting Accessories (Please find in On-wall Installation Kit Box):

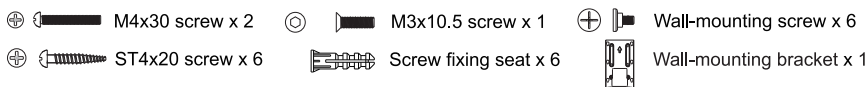

Flush mounting Accessories (Please find in In-wall Installation Kit Box):

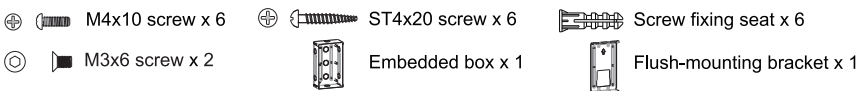

Product Overview

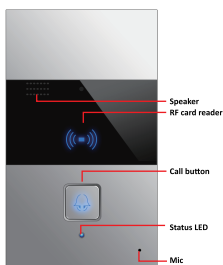

R23C

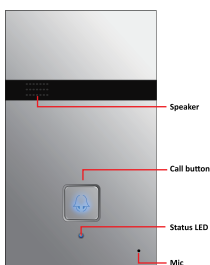

R23P

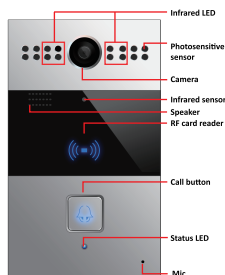

R26C

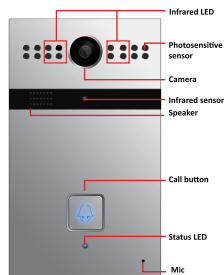

R26P

Installation

Step 1: Bracket/Box Installation

Wall Mounting

With 86 embedded box in the wall

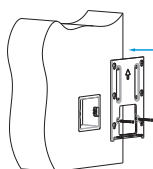

Fix the wall-mounting bracket on embedded box with two M4x30 screws.

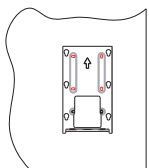

Mark the four holes of the wall-mounting box on the wall.

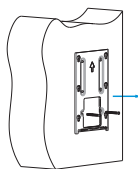

Take down the M4x30 screws and remove the wall-mounting bracket.

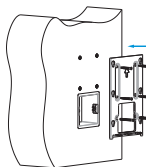

Fix the wall-mounting bracket with four ST4x20 screws and two M4x30 screws.

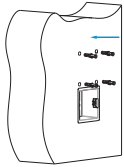

Insert four screw fixing seats into the hole.

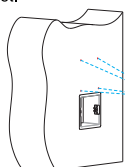

Use a hand drill with 5mm diameter bit to make holes in the marked positions.

Without 86 embedded box in the wall

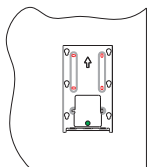

Mark the four holes of the wall-mounting bracket on the wall.

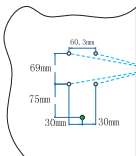

Use a hand drill with 5mm diameter bit to make the hole in marked positions.

*Please note the relative position in the left figure.

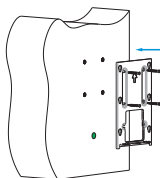

Fix the wall-mounting bracket with four ST4x20 screws.

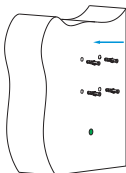

Insert four screw fixing seats into the holes.

Flush Mounting

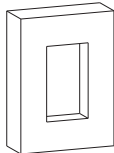

Dig out a square hole (height*width*depth=201.5*115.9*60mm), for inserting the embedded box.
Note: The size of the hole should be a little larger than recommended value that can accommodate all cables.

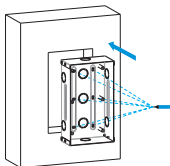

Insert the embedded box into the hole and make sure the cables of the device can route through the cable hole. Then mark the six screw holes of the wall embedded box on the wall.

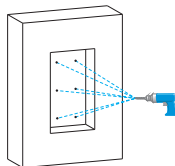

Take down the embedded box, then use a hand drill with 5mm diameter bit to make holes in the marked positions.

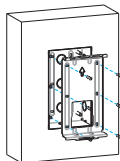

Use six M4x10 screws to fix the flush-mounting bracket on the embedded box.

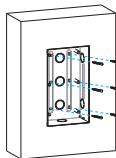

Place the embedded box into the square hole until the edges of which align to the cable hole. Fix the embedded box with six ST4x20 screws. Then use cement or non-corrosive structural adhesives to fill the gap between the wall and embedded box.

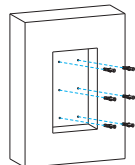

Insert six screw fixing seats into the holes you drilled before.



Or you can choose another simple method without fixing ST4x20 screws

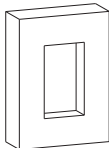

Dig out a square hole (height*width*depth=201.5*115.9*60mm), for inserting the embedded box.
Note: The size of the hole should be a little larger than recommended value that can accommodate all cables.

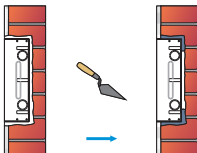

Use cement or non-corrosive structural adhesives to fill the gap between the wall and embedded box. Wait the adhesive material desiccation, go to the next step.

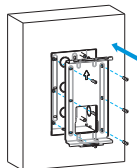

Use six M4x10 screws to fix the flush-mounting bracket on the embedded box.

Step 2: Back cover Installation

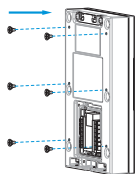

Fix six wall-mounting six screws in the back of R23X/R26X (only for wall mounting installation).

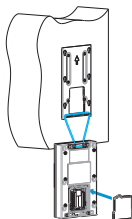

For convenient wiring, hang R23X/R26X on the wall-mounting / flush-mounting bracket with rope. Then insert the silicon rubber sealing ring into the groove.

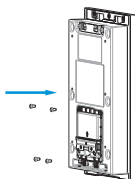

Fix the back cover with four M3X5 screws.

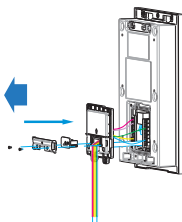

Make cables go through the back cover, connecting to the corresponding interfaces of the main board. Choose a suitable size rubber plug to compress cables, then fasten the locking cable plate with two ST1.7x4 screws.

Step 3: Device Mounting

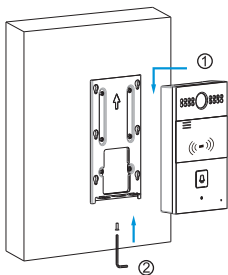

One M3x6 screw

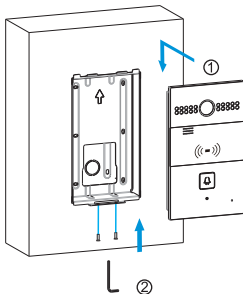

Two M3x10.5 screw

1. Place the device into the wall-mounting / flush-mounting bracket until the edges of which align to the wall. Then pull the device downward and ensure the groove of it hooks to the lock catches of the back box.

2. Use the Allen wrench to tighten the device with the screws.

Application Network Topology

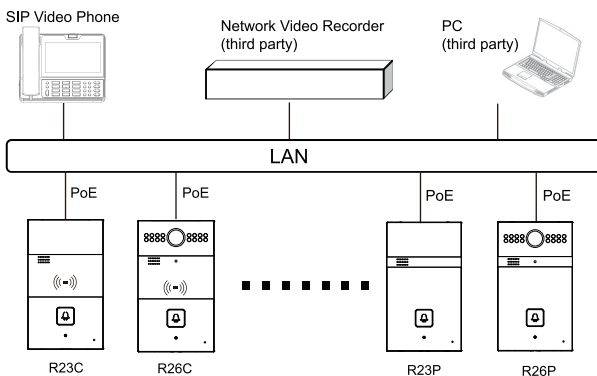

IP Announcement

1. While R23X/R26X starts up normally, hold the call button for several seconds after the LED light turns blue, voice system will enter IP announcement mode.
2. In announcement mode, the IP address will be announced periodically.
3. Press Call Button again to the announcement mode.
4. In announcement mode, phone announces "IP 0.0.0.0" if no IP address is gained.

Configuration

1. Access the Web UI: Input the IP address into browser to configure the phone.
2. Account Registration: On web UI, go to the path: **Account -> Basic** page Register Account and fill in the account information. (Please refer to user manual for more information)
3. Configure the Push Button: On web UI, go to the path: **Intercom -> Basic -> Push Button** to configure the call number.
4. Configure the code to open the relay: On web UI, go to the path: **Intercom -> Relay&Input -> Relay ID/DTMF** and choose the DTMF code number in corresponding area.

Operation



Make a call:











1. Press the call button to call indoor SIP Phone.
2. During the talk, called party can press pre-configured code number to unlock the door.

Receive a call:

R23X/R26X supports Auto Answer by default. Incoming call from indoor device will be answered automatically.

Indicators

 Light ON  Light OFF

Name	Status	Description
Status indicator	Blue	 Normal status
	Red	 0.25sec →  0.25sec Calling
		 0.05sec →  0.05sec Restarting
	Green	 Initialing/Talking on a call
		 0.25sec →  0.25sec Receiving a call
	Red/Blue	 0.05sec →  0.05sec →  0.05sec Firmware upgrading

Note: For more LED settings, please refer to R23X/R26X webUI: Intercom -> LED Setting.

Notice Information

Akuvox R23X/R26X firmware contains third-party open source software under the terms of the GNU General Public License(GPL). Akuvox is committed to meeting the requirements of the GNU General Public License (GPL) and will make all required source code available.

The source code of software under the terms of GNU GPL can be downloaded online: <http://www.akuvox.com/gpl>.

Information contained in this document is believed to be accurate and reliable at the time of printing. This document is subject to change without notice, any update to this document can be viewed on Akuvox' s website: <http://www.akuvox.com> © Copyright 2019 Akuvox Ltd. All rights reserved.



AKUVOX (XIAMEN) NETWORKS CO., LTD.
 ADD: 10/F, NO.56 GUANRI ROAD, SOFTWARE PARK II, XIAMEN 361009, CHINA
www.akuvox.com



YS2600006