

Unpacking

Please make sure the package contains the following items:

Universal Accessories (Please find in device box):

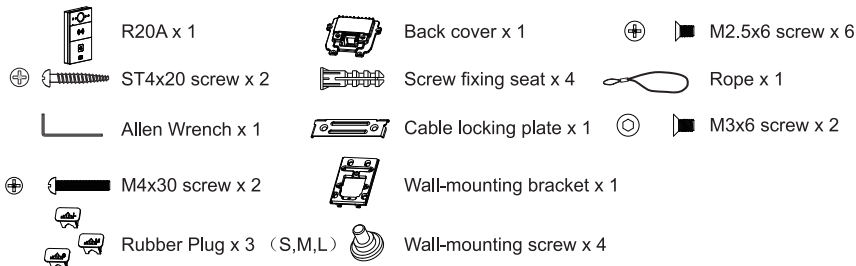

Flush-mounting Accessories :

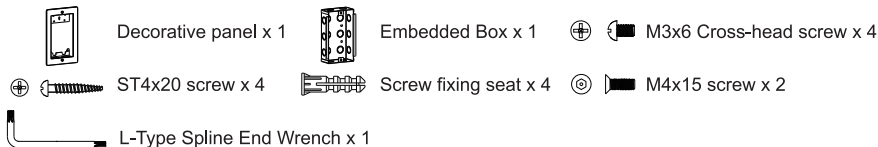

Product Overview

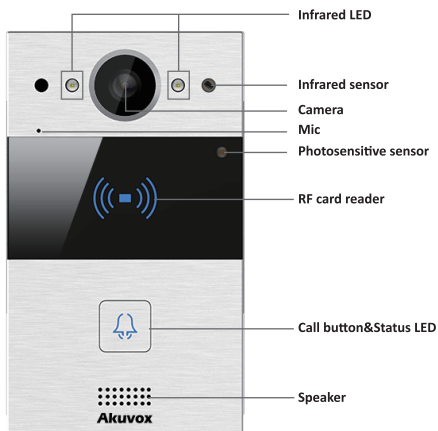

R20A

Installation

Step 1: Embedded/Box Installation

Flush Mounting

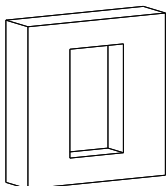

According to the position of the cable, cut a square hole in wall. (height*width*depth=180*101*50 mm). Note: The size of the hole should be a little larger than recommended value that it can accommodate all needed cables.

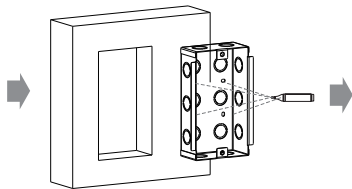

Insert the embedded box into the hole and make sure the cables of the device can route through the cable hole then mark the four screw holes of the wall embedded box on the wall.

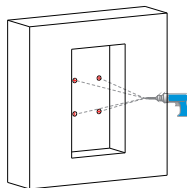

Take down the embedded box then use a 5 mm hand drill to make holes with a depth of 25 mm at the marked positions.

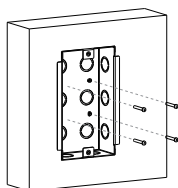

Fix the embedded box with four ST4x20 screws. Then use cement or non-corrosive structural adhesives to fill the gap between the wall and embedded box.

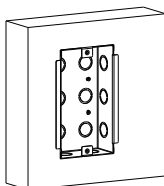

Place the embedded box into the square hole until the edges of which align to the wall and make all cables go through the cable hole.

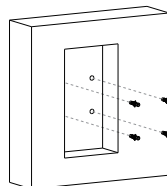

Insert four screw fixing seats into the holes.

Or you can choose another simple method without fixing ST4x20 screws

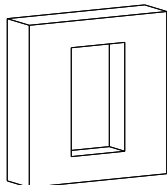

According to the position of the cable cut a square hole in the wall (height*width*depth=180*101*50 mm). Note: The size of the hole should be a little larger than recommended value that it can accommodate all needed cables.

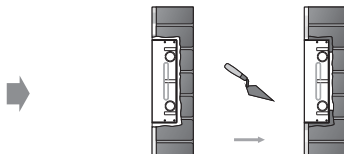

Use cement or non-corrosive structural adhesives to fill the gap between the wall and embedded box. Wait the adhesive material desiccation, go to the next step.

Step 2: Decorative Panel and Back cover Installation

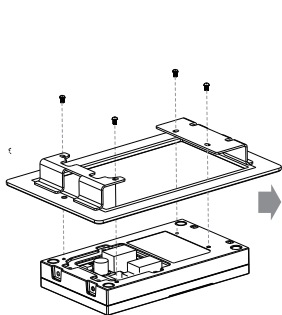

Use four M3x6 Cross-head screws to fix R20 on the decorative panel .

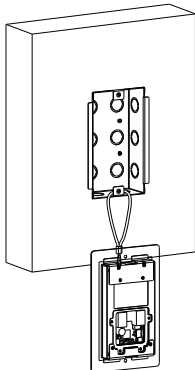

For convenient wiring, hang R20 on the embedded Box with rope.

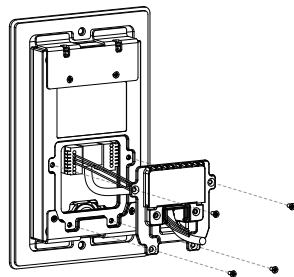

Make cables go through the back cover, connecting to the corresponding interfaces of the main board. Fasten the back cover with four M2.5x6 screws.

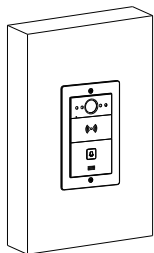

After successful installation, check the stability of device.

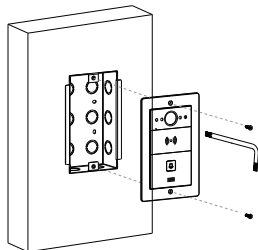

Place the device into the embedded box, then use L-Type Spline End Wrench to tighten the device with two M4x15 screws.

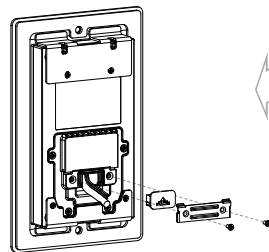

Select a suitable size rubber plug to push all the cables into the back cover. Fix cable locking plate to the back cover with two M2.5x6 screws.

Application Network Topology

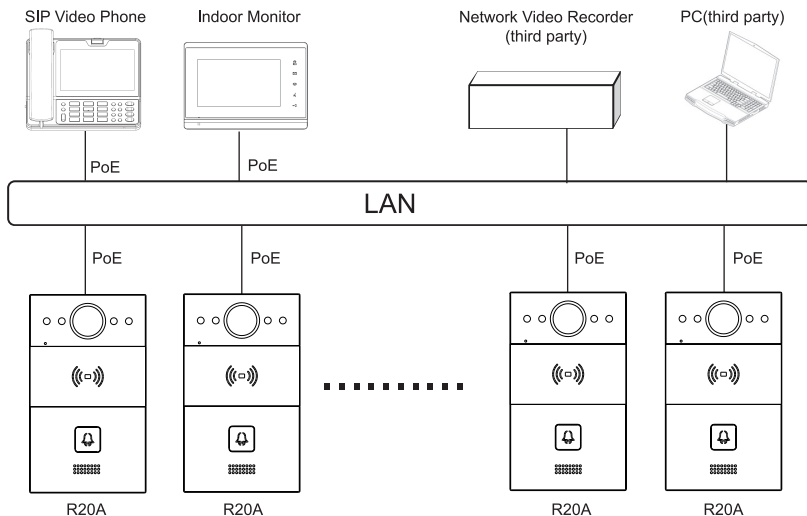

IP Announcement

1. While R20A starts up normally, hold the call button for several seconds after the Status LED turns blue, voice system will enter IP announcement mode.
2. In announcement mode, the IP address will be announced periodically.
3. Press Call Button again to quit the announcement mode.
4. In announcement mode, phone announces "IP 0.0.0.0" if no IP address is gained.

Configuration

1. Access the Web UI: Input the IP address into web browser to configure the phone.
2. Account Registration: On web UI, go to the path: **Account -> Basic** page
Register Account and fill in the account information. (*Please refer to user manual for more information*)
3. Configure the Push Button: On web UI, go to the path: **Intercom -> Basic -> Push Button** to configure the call number.
4. Configure the code to open the relay: On web UI, go to the path: **Intercom -> Relay -> Relay ID/DTMF** and choose the DTMF code number in corresponding area.

Operation

Make a call:













1. Press the call button to call indoor SIP Phone.
2. During the talk, called party can press pre-configured code number to unlock the door.

Receive a call:

R20A supports Auto Answer by default. Incoming call will be answered automatically.

Indicators

 Light ON  Light OFF

Name	Status	Description	
Status indicator	Blue		Normal status
		 0.25sec → 	Calling
	Red	 0.05sec → 	Restarting
		 0.25sec → 	Network is unavailable
	Green		Initiating/Talking on a call
		 0.25sec → 	Receiving a call
	Red/Blue	 0.05sec →  0.05sec	Firmware upgrading

Note: For more LED settings, please refer to R20A webUI: Intercom -> LED Setting.

Notice Information

Akuvox R20A firmware contains third-party open source software under the terms of the GNU General Public License (GPL). Akuvox is committed to meeting the requirements of the GNU General Public License (GPL) and will make all required source code available.

The source code of software under the terms of GNU GPL can be downloaded online: <http://www.akuvox.com/gpl>.

Information contained in this document is believed to be accurate and reliable at the time of printing. This document is subject to change without notice, any update to this document can be viewed on Akuvox' s website: <http://www.akuvox.com> © Copyright 2019 Akuvox Ltd. All rights reserved.



AKUVOX (XIAMEN) NETWORKS CO., LTD.
 ADD: 10/F, NO.56 GUANRI ROAD, SOFTWARE PARK II, XIAMEN 361009, CHINA
www.akuvox.com

