

4 in 1 Sensor (Temperature /Humidity /Brightness /Motion)

Ver2.1

SNR0304



Content

1. Summary.....	1
2. Product and Feature Overview.....	1
3. Specification	1
4. Dimensional Drawings, Wiring Diagrams and Sensing Schematics	2
5. Parameter setting and communication object description	2
5.1 Overview of App Features.....	2
5.2 Function parameter setting	3
5.2.1 General.....	3
5.2.2 Illumination detector	4
5.2.3 Motion detector.....	7
5.2.4 Temperature detector.....	10
5.2.5 Humidity detector.....	12
5.2.6 Device status feedback.....	14
6. Communication object description	14
6.1 Illumination function communication object	14
6.2 Mobile sensing function communication object.....	15
6.3 Communication object of temperature function	17
6.4 Humidity function communication object.....	18
6.5 device status feedback.....	18
7. Safe use and maintenance.....	19
8. Contact.....	19

1. Summary

This manual provides the user with detailed technical information on the 4-in-1 sensor, including installation and programming details, and explains how to use the 4-in-1 sensor based on practical examples, which are in-ceiling mounted.

There are many applications for the four-in-one sensor, which can be used in applications related to brightness, humidity, temperature, and infrared movement requirements;

It is installed as a system with other devices via the EIB/KNX bus.

The entire system is set up and operated using the engineering design tool software ETS.

2. Product and Feature Overview

The four-in-one sensor is mainly installed on the ceiling. It is a device that can sense external signals and physical conditions (such as light, movement, temperature, and humidity), and transmit the sensed information to other devices (such as dimmers, relay) to achieve its function. Connect to the EIB / KNX system through the EIB bus terminal block, and use the engineering design tool software ETS software (version ETS4.0 or later) to assign physical addresses and set parameters.

Function description:

- (1) Illumination, temperature, humidity value cycle output function
- (2) Illumination, temperature, and humidity control two channels each, which can output 1bit, 4bit, 1byte data
- (3) Infrared mobile trigger control function
- (4) Temperature change trigger control function
- (5) Humidity change trigger control function
- (6) Infrared movement and brightness logic function
- (7) Infrared mobile master-slave function
- (8) Enable or disable the channel control output function of illuminance, infrared movement, temperature, and humidity through the object
- (9) Combined use of illuminance and movement to jointly control the function of light
- (10) Combined use of temperature and humidity can jointly control the switch of the air conditioner
- (11) Four-in-one sensor for infrared movement, illumination, temperature and humidity

3. Specification

Bus input	21-30V DC
Bus current	≤ 12mA
Working power	< 360mW
Sensing distance	Installation height 2.5m~3m, radiation range 5m~7m
Shell material	PC
Dimensions (H x W x D)	Height H=45mm Diameter=60mm
Hole Size	Φ46mm≤d≤Φ52mm
Installation method	Embedded installation (recommended hole size: diameter 46mm)
Weight(approx.)	0.05KG
Operating temperature	-5°C- 45°C
Storage temperature	-20°C- 55°C
Transportation temperature	-25°C...+70°C

Relative humidity	max 90%
-------------------	---------

4. Dimensions, wiring diagrams and induction diagrams

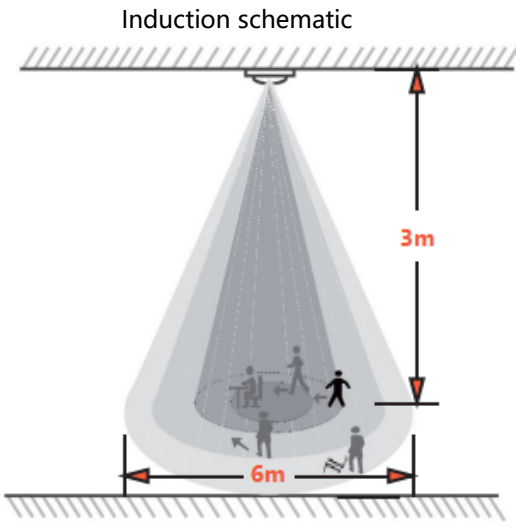
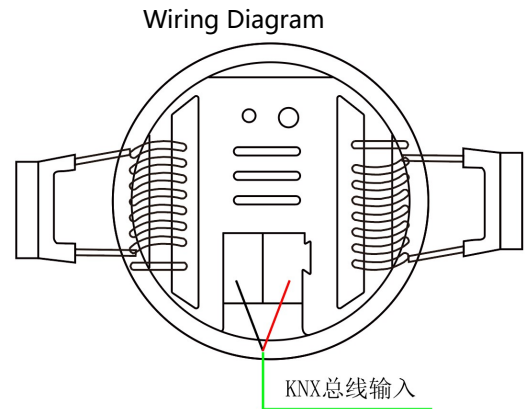
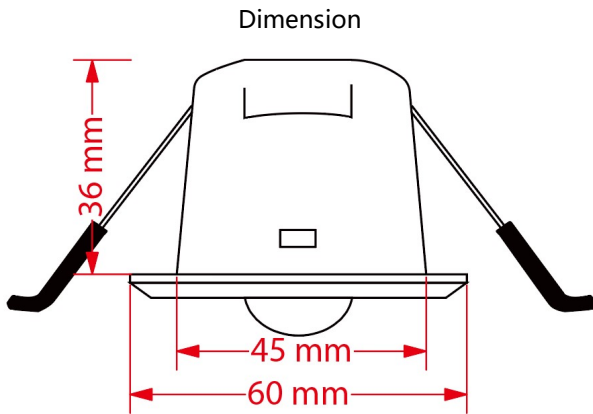

H: range size 2.5m~3m, recommended value: 2.7m
 D1: Range: 4m~5m, high sensitivity range
 D2: Range: 5m~7m, maximum sensing range

5. Parameter setting and communication object description

5.1 Overview of App Features

Illumination function

This function is mainly used for lighting, such as outdoor lighting. We often need to turn on the light when it is dark, and turn off the light when it is bright. The sensor can easily realize this operation process, and the sensor can automatically sense the current illuminance to achieve automatic. When it detects that the brightness in the house is the set limit value, the constant illuminance control function can be completed through the connected dimmer.

Moving function

The movement function mainly implements the action when the sensor senses that someone is moving, and ends the action when no person is sensed for a period of time. For example, on a public aisle, you can set the sensor to

automatically turn on the light when it senses someone walking, and automatically turn off the light after a delay after the person walks, so as to achieve the greatest energy saving effect. It can also be used in other occasions, such as elevator halls, underground garages and other areas

Temperature function

The temperature function mainly executes the action when the outside temperature is higher (or lower) than the temperature set threshold, and ends the action when the temperature is lower (or higher) than the temperature threshold. For example, the set temperature threshold is 28°C. When the outside temperature is higher than 28°C, the air conditioner is turned on. After running for a period of time, when the temperature drops below 28°C, the air conditioner is turned off, so that the indoor temperature is constant within a certain range. In order to avoid cold or high temperature discomfort.

Humidity function

The humidity function mainly performs actions when the external humidity is higher (or lower) than the set humidity threshold, and ends when the humidity is lower (or higher) than the humidity threshold. For example, the set humidity threshold is 60%. When the external humidity is higher than 60%, the dehumidifier is turned on. After running for a period of time, when the humidity drops below 60%, the dehumidifier is turned off, so that the indoor humidity is constant within a certain range. , to avoid the humidity is too low or too high, causing bad images on the human body.

Logical function

The logic function is to integrate the illumination and movement functions, and combine the illumination and movement functions. For example, to control home lighting, we want the light to turn on automatically as soon as we walk into the room, but we don't need to perform this action during the day, only at night, and when people leave or the sensor can't sense any movement, the light will turn on for a period of time. Automatic shutdown, the entire process of light control can be automatically completed by this logic function of the sensor.

Master-slave function

The master-slave function of a sensor is generally used in situations where multiple sensors control one or one type of equipment at the same time. When the main sensor receives the specified information from the sensor, it outputs the start value. After a delay for a period of time, if it does not receive the information from the sensor during this time, it outputs the end value. When this specified value is received, the delay restarts. For example, several sensors control a light at the same time. One of the slave sensors senses that someone has moved. At this time, the slave sensor sends a message. After the master sensor receives the specified message, it outputs a message and turns on the light. If the specified information is not received, the main sensor outputs a message again to turn off the light

Prohibition of movement, illumination, temperature, humidity and logic functions

This function is convenient for some occasions and situations where it is necessary to disable illumination, movement, temperature, humidity or logic. When the illumination or movement of a sensor is prohibited, changes in illumination, movement, temperature and humidity will no longer affect this sensor. After the logic function is disabled, the sensor will no longer perform logic operations.

5.2 Function parameter setting

The following takes ETS5 as an example to set parameters in ETS5.

5.2.1 General

Open the parameter setting interface of the illuminance infrared motion sensor in ETS5, as shown in Pic 5.2.1. The

"General" parameter setting interface can set whether to disable/enable functions such as illumination sensing, motion sensing, and device status feedback.

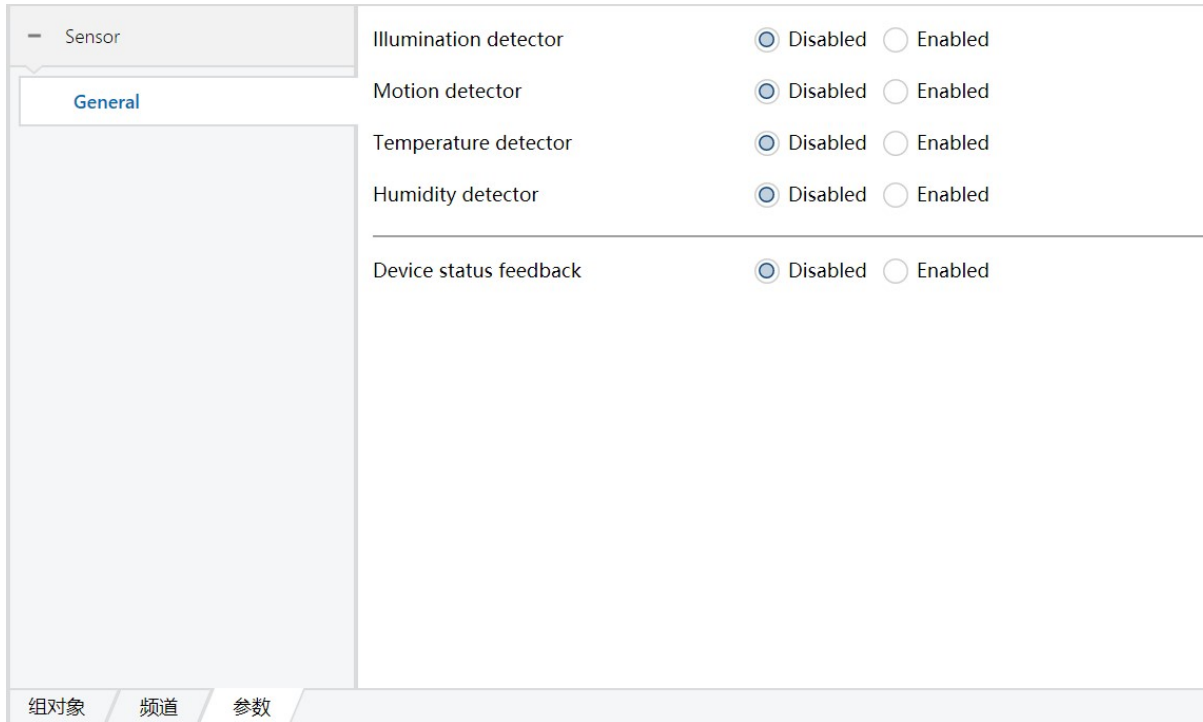

Pic 5.2.1

Parameter	Description
Illumination detector	Option: disable, enable
Motion detector	Option: disable, enable
Temperature detector	Option: disable, enable
Humidity detector	Option: disable, enable
Device status feedback	Option: disable, enable

5.2.2 Illumination detector

"Illumination detector" The parameter setting interface is shown in Pic 5.2.2

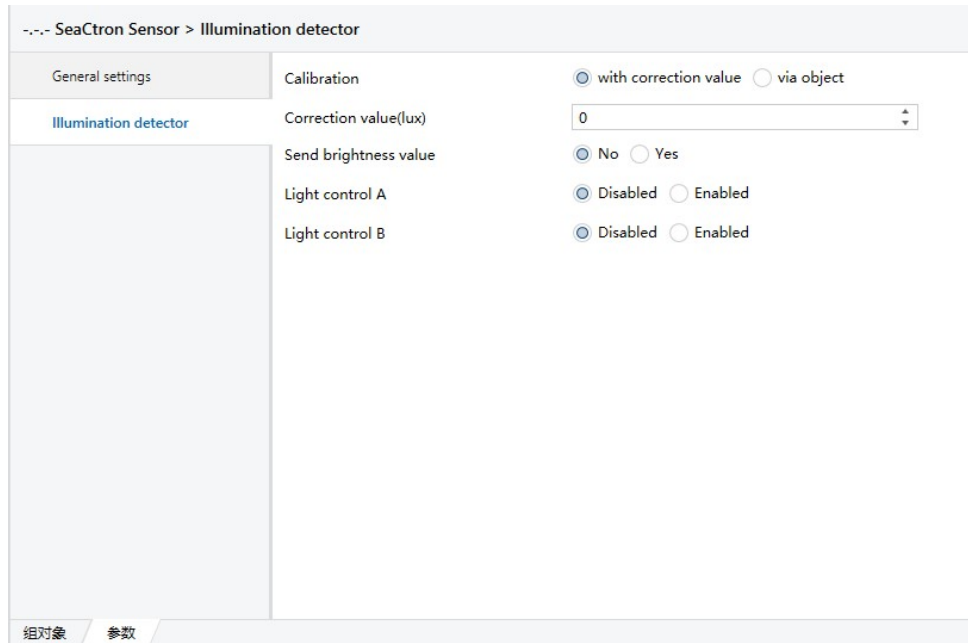

Pic 5.2.2

Parameter	Description
Calibration	This parameter is only used for the calibration of the brightness value when the brightness value is obtained from the inside. The options are: with correction value (representing that the correction value is filled in the VD library for correction), via object (correction by the object). When with correction value is selected, the parameter correction value (lux) (correction value) will appear, and the fillable range is -200~200. For example: when the actual brightness value is 100lux, the detection value inside the sensor is 150lux. Fill in the correction value -50lux in the VD library, or correct -50lux through the object.
Send brightness value	Use this parameter to determine whether to send the brightness value to the bus, options: "yes" or "no". When "yes" is selected, the parameter "the mode for sending value" appears, the options are: "transmit value in the event of changes" (send data once the brightness value changes), "transmit value in cycles" (send data cyclically). When "transmit value in the event of changes" is selected, the parameter "send brightness value on change" appears (when the change exceeds how much, the brightness value is sent to the bus), options: change \geq 10lux, change \geq 25lux, change \geq 50lux, change \geq 75lux, change \geq 100lux); when "transmit value in cycles" is selected, the parameter "the time in cycles" (cycle time) appears, options: 1 seconds, 2 seconds...120minutes.
Sending brightness value	This parameter is used to determine whether to send the internally detected illuminance value to the bus, options: "yes" or "no". When "yes" is selected, the parameter "the mode for sending value" appears, the options are: "transmit value in the event of changes" (as long as the brightness value changes over a certain value), "transmit value in cycles" (loop send). When "transmit value in the event of changes" is selected, the parameter "send brightness value on change" (send data when the illumination value changes a certain value) appears. Options are: "change \geq 10", "change \geq 25", "change \geq 50", "change \geq 75", "change \geq 100"); when "transmit value in cycles" is selected, the parameter "the time in cycles" (cycle time) appears, options 1seconds, 2seconds ...120minutes

Light control A	Indicates the light control channel A, options: "enable" (enable), "disable" (disable). When "enable" is selected, the interface will appear as shown in Pic 5.2.3
Light control B	Indicates light control channel B (same as Light control A)

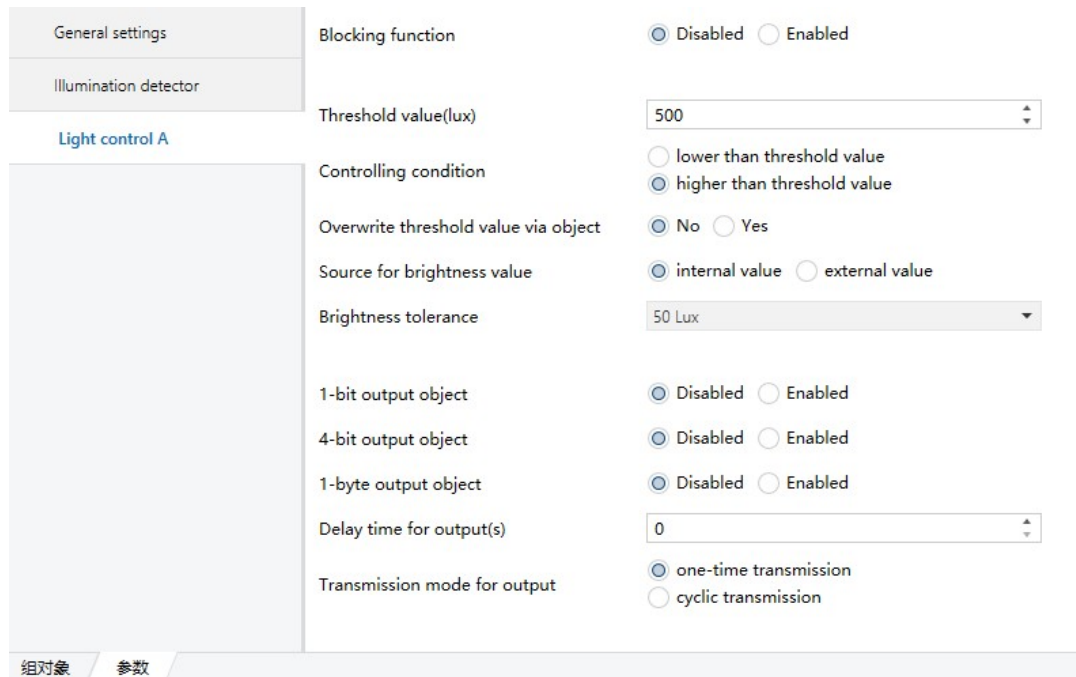

Pic 5.2.3

Parameter	Description
Blocking function	Block function, options: "Enabled", "Disabled". When "Enabled" is selected, the parameter "blocking value" appears, and the options are: "blocking=1, unblocking=0", "blocking=0, unblocking=1", blocking value after voltage recovery (power off Blocking state after recovery), options: "blocking", "unblocking", "as before voltage failure".
Threshold value (lux)	Indicates the threshold, optional: 0-1200.
Controlling condition	Control conditions, optional options: "higher than threshold value" (above the threshold), lower than threshold value (below the threshold)
Overwrite threshold value via object	This parameter is used to override the threshold by object, optional: "Yes", "No"
Source for brightness value	Option: "internal value" 、 "external value"
Brightness tolerance	Option: 10lux、 25lux、 50lux、 75lux、 100lux、 150lux、 200lux
1-bit output object	This parameter is used to output 1bit data, options are: "Enabled", "Disabled". When "Enabled" is selected, the parameter "1-bit value" will appear, with options: "on", "off".
4-bit output object	This parameter is used to output 4-bit data, the options are: "Enabled" to enable, "Disabled" to disable. When "Enabled" is selected, the parameter "4-bit value" appears, the options are: "Decrease, Break" (decrease, interrupt), "Decrease 1%"..."Decrease 100%", "Increase, Break", "Increase 1%"..."Increase 100%"
1-byte output object	This parameter is used to output 1byte data, the options are: "Enabled" to enable, "Disabled" to disable. When "Enabled" is selected, the parameter "1-byte type" appears, the options are: "scene number (1..64)" (scene number), "percentage (0%...100%" (percentage), " unsigned value(0...255)" (unsigned value); when selecting "scene number (1..64), the parameter "scene number" (scene number) appears, which can be filled in from 1 to 64; when selecting "percentage (0%...100%)", the parameter "percentage"

	appears, you can choose 0%~100%; when you choose "unsigned value(0...255)", the parameter "unsigned value" appears, you can fill in 0~255 .
Delay time for output(s)	This parameter is used to determine the output delay time, which can be filled from 0 to 255.
Transmission mode for output	Output transmission mode, options: "one-time transmission", "cyclic transmission". When "cyclic transmission" is selected, the parameter "cyclic time for output" (interval time of cyclic output) appears, options: "1seconds", "2seconds"... "120minutes".

5.2.3 Motion detector

“Motion detector” The parameter setting interface is shown in Pic 5.2.4

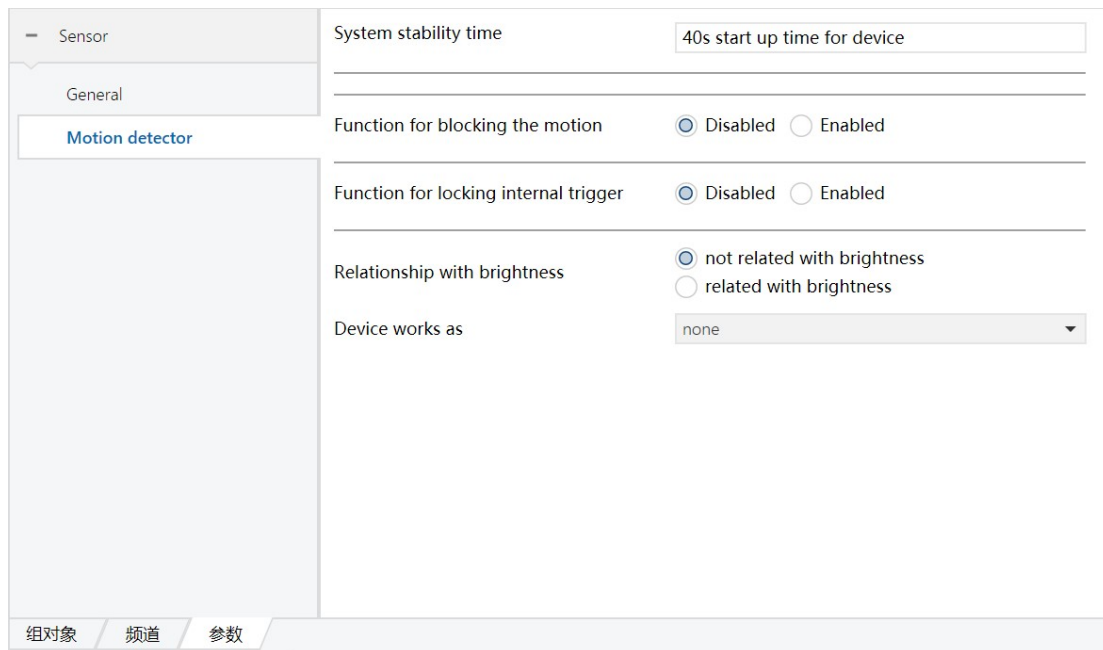

Pic 5.2.4

Parameter	Description
System stability time: 40s start up time for device	This parameter indicates that the device startup time is 40s
Function for blocking the motion	Block the motion sensing function, options: "enable", "disable". When "enable" is selected, the parameter "blocking value" appears, the options are: "blocking=1, unblocking=0", blocking value after voltage recovery. Blocking state after power recovery), options: "blocking", "unblocking", "as before voltage failure"
Function for locking internal trigger	Block internal trigger function, options: "enable", "disable". When "enable" is selected, the parameter "locking value" appears, the options are: "locking=1, unlocking=0", "locking=0, unlocking=1"; locking value after voltage recovery after the blocking state), options: blocking", "unblocking", "as before voltage failure"
Relationship with brightness	This parameter is used to determine whether the control of the motion sensing is related to the brightness. The options are: "not related with brightness", "related with brightness", when "related with brightness" is selected, the parameter "threshold value" appears, you can fill in 0~1200, overwrite threshold value via object, options: "yes", "no"; "source for brightness value" source), optional: "internal value", "external value"
Device works as	This parameter indicates the working mode of the device, with options: "none", "single or master mode" (single or master mode), "slave mode" (slave mode). When selecting "single

or master mode", the interface will appear as shown in pic 6.1.5; When "slave mode" is selected, the interface will appear as shown in pic 5.2.5

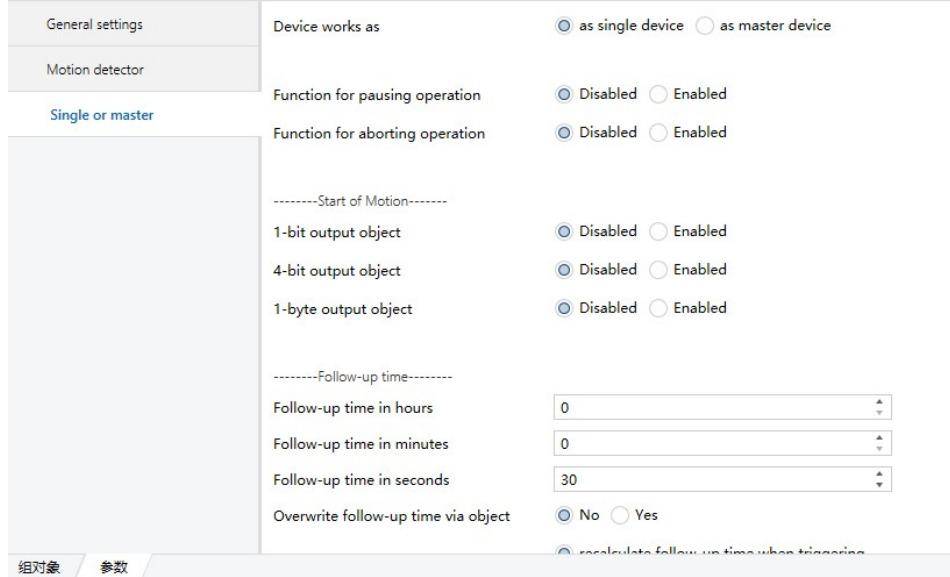

Pic 5.2.5

Parameter		Description
Device works as		Device function mode, options: "as single device", "as master device". When "as master device" is selected, the parameter "input value as master" appears, with options "on" and "off".
Function for pausing operation		Pause operation function, options: "enable", "disable". When "enable" is selected, the parameter "for current operation" appears, the options are: "pause=0, continue=1", "pause=1, continue=0"
Function for aborting operation		This parameter is used to perform forced reset operation for motion sensing, options: "enable", "disable". When "enable" is selected, the parameter "for current operation" appears, the options are: "abort when receiving 0", "abort when receiving 1"
Start of motion	1-bit output object	This parameter is used to output 1bit data, options: "enable", "disable". When "enable" is selected, the parameter "1-bit value" appears, the options are "on", "off".
	4-bit output object	This parameter is used to output 4-bit data, options: "enable", "disable". When "enable" is selected, the parameter "4-bit value" appears, the options are: "Decrease, Break", "Decrease 1%" ... "Decrease 100%", "Increase, Break", "Increase 1%" ... "Increase 100%"
	1-byte output object	This parameter is used to output 1byte data, options: "enable", "disable". When "enable" is selected, the parameter "1-byte type" appears, the options are: "scene number (1...64)", "percentage (0%...100%)", "unsigned value (0...255)". When "scene number (1...64)" is selected, the parameter "scene number" appears, and 1~64 can be filled; when "percentage (0%...100%)" is selected, the parameter "percentage" appears, and 0 is optional. %~100%; when "unsigned value(0...255)" is selected, the parameter "unsigned value" appears, which can be filled with 0~255.
Follow-up time	Follow-up time in hours	Duration (in hours), you can fill in "0-23".
	Follow-up time in minutes	Duration (in minutes), you can fill in "0-59".

	Follow-up time in seconds	Duration (in seconds), you can fill in "0-59".
	Override follow-up time via object	Options: "yes" 、 "no" 。
	Motion trigger during follow-up time	This parameter is used to set whether to recalculate the duration when the motion sensing is re-triggered. The options are: "recalculate follow-up time when trigger", "not recalculate follow-up time when trigger".
End of motion	1-bit output object	This parameter is used to output 1-bit data, options: "enable", "disable", when "enable" is selected, the parameter "1-bit value" appears, options: "on", "off".
	4-bit output object	This parameter is used to output 4-bit data, options: "enable", "disable", when "enable" is selected, the parameter "4-bit value" appears, options: "Decrease, Break", "Decrease 1% ..." "Decrease 100%", "Increase, Break", "Increase 1% ..." "Increase 100%".
	1-byte output object	This parameter is used to output 1byte data, options: "enable", "disable". When "enable" is selected, the parameter "1-byte type" appears, the options are: "scene number (1...64)", "percentage (0%...100%)", "unsigned value (0...255))"; when "scene number (1...64)" is selected, the parameter "scene number" appears, and 1~64 can be filled; when "percentage (0%...100%)" is selected, the parameter "percentage" appears, Optional 0%~100%; when "unsigned value(0...255)" is selected, the parameter "unsigned value" appears, and 0~255 can be filled.
Dead time after end of motion(s)	This parameter is used for the sensor to sense no one for a period of time. After sending the execution action to the bus, the sensor does not perform any operation after a certain period of time. You can fill in "0-255".	

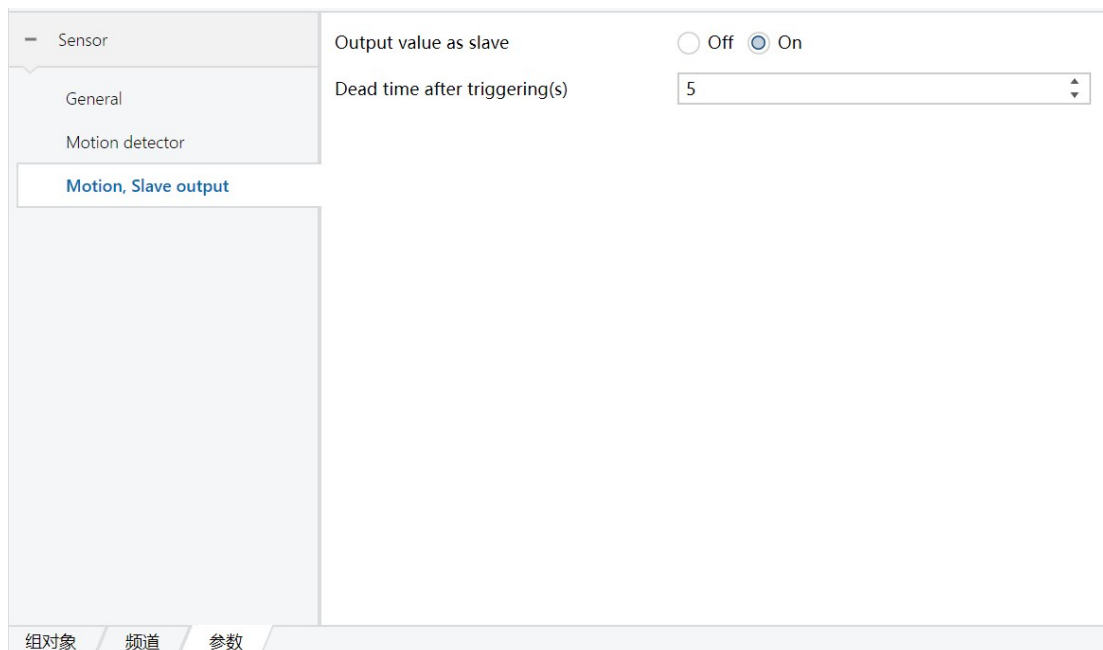

Pic 5.2.6

Parameter	Description
Output value as slave	Output value as slave device (options: "on", "off")
Dead time after triggering (s)	This parameter is used to perform no operation after a certain period of time after the slave sensor is triggered (can be filled with "0-255")

5.2.4 Temperature detector

Temperature detector” The parameter setting interface is shown in Pic 5.2.7

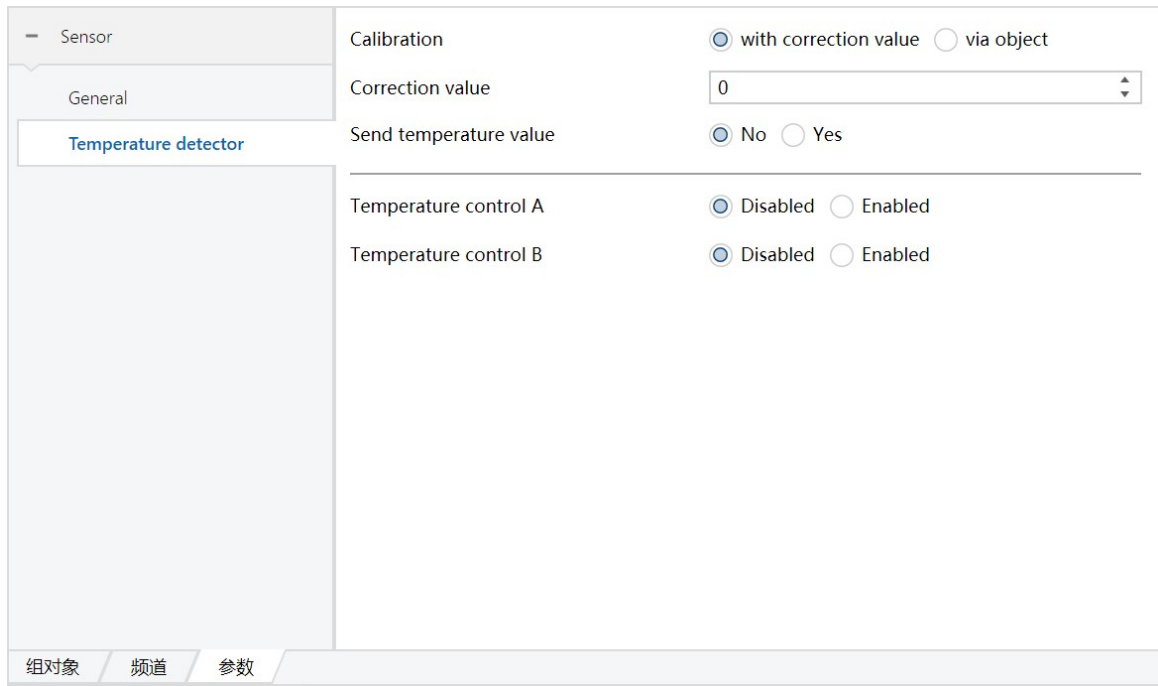

Pic 5.2.7

Parameter	Description
Calibration	This parameter is only used to calibrate the temperature value when the temperature value is obtained from the inside, the options are: with correction value, via object. After selecting with correction value, the parameter correction value will appear, and the fillable range is -50~50. For example: when the actual temperature value is 25°C, the detected value inside the sensor is 35°C, and it needs to be filled in the VD library. Corrected value -10°C, or corrected by object -10°C.
Send temperature value	Use this parameter to determine whether to send the temperature value to the bus, options: "Yes" or "No". When selecting "Yes", the parameter "the mode for sending value" appears, with options: "transmit value in the event of changes", "transmit value in cycles". When "transmit value in the event of changes" is selected, the parameter "send brightness value on change" appears, the options are: change>=0.5, change>=1.0, change>=1.5, change>=2.0...change>= 10; When "transmit value in cycles" is selected, the parameter "the time in cycles" appears, with options: 1 seconds, 2 seconds... 120minutes.
Light control A	Indicates temperature control channel A, options: "Enabled", "Disabled". When "Enabled" is selected, the interface will appear as shown in Pic 5.2.8
Light control B	Indicates temperature control channel B (same as Light control A)

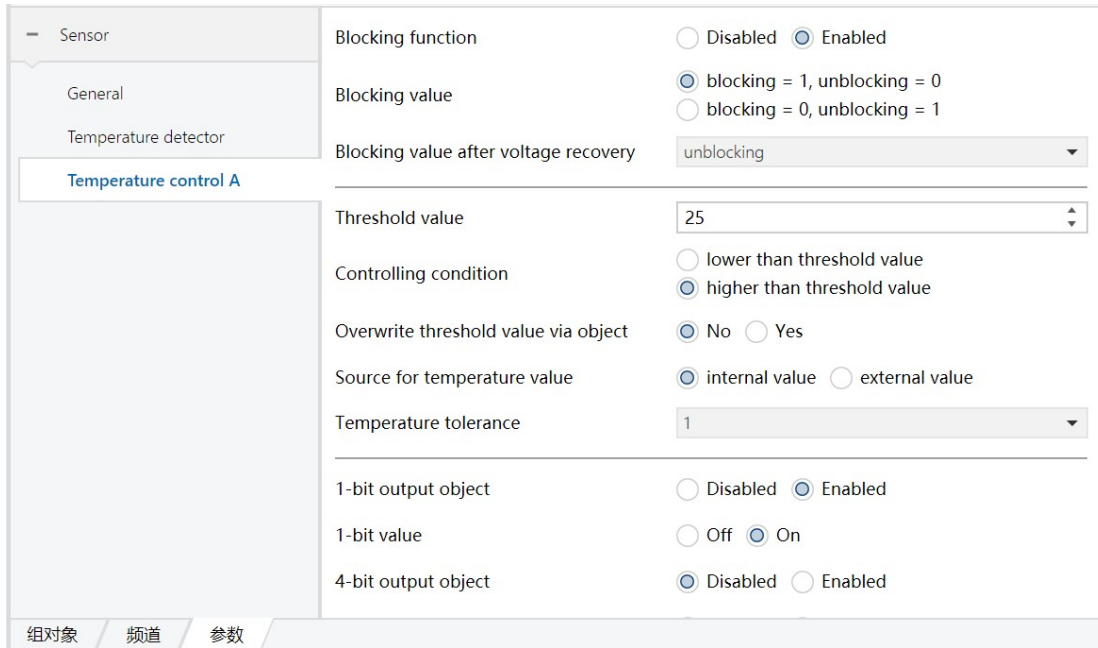

The screenshot shows a configuration window for a sensor. On the left, there is a sidebar with a tree view containing 'Sensor', 'General', 'Temperature detector', and 'Temperature control A' (which is selected). The main area displays the following parameters:

- Blocking function:** Radio buttons for Disabled and Enabled (Enabled is selected).
- Blocking value:** Radio buttons for 'blocking = 1, unblocking = 0' (selected) and 'blocking = 0, unblocking = 1'.
- Blocking value after voltage recovery:** A dropdown menu with 'unblocking' selected.
- Threshold value:** A numeric input field with '25'.
- Controlling condition:** Radio buttons for 'lower than threshold value' and 'higher than threshold value' (selected).
- Overwrite threshold value via object:** Radio buttons for No (selected) and Yes.
- Source for temperature value:** Radio buttons for internal value (selected) and external value.
- Temperature tolerance:** A dropdown menu with '1' selected.
- 1-bit output object:** Radio buttons for Disabled and Enabled (Enabled is selected).
- 1-bit value:** Radio buttons for Off and On (On is selected).
- 4-bit output object:** Radio buttons for Disabled (selected) and Enabled.

At the bottom, there are three tabs: '组对象' (Group Object), '频道' (Channel), and '参数' (Parameter).

Pic 5.2.8

Parameter	Description
Blocking function	Block function, options: "Enabled", "Disabled". When "Enabled" is selected, the parameter "blocking value" will appear, options: "blocking=1, unblocking=0", "blocking=0, unblocking=1", blocking value after voltage recovery, options: "blocking", "unblocking", "as before voltage failure".
Threshold value (lux)	Indicates the threshold, options: -20~80.
Controlling condition	Options: "higher than threshold value", lower than threshold value
Overwrite threshold value via object	Optional: "Yes", "No"
Source for temperature value	Optional: "internal value", "external value"
temperature tolerance	Options: 1°C, 2°C, 3°C, 4°C, 5°C, 6°C, 7°C, 8°C, 9°C, 10°C.
1-bit output object	This parameter is used to output 1bit data, options are: "Enabled", "Disabled". When "Enabled" is selected, the parameter "1-bit value" appears, the options are "on", "off".
4-bit output object	This parameter is used to output 4-bit data, the options are: "Enabled" to enable, "Disabled" to disable. When "Enabled" is selected, the parameter "4-bit value" will appear, the options are: "Up, Break", "Up, 100%"..."Up, 1%", "down, Break", "down 100%" "...down 1%"
1-byte output object	This parameter is used to output 1byte data, options: "Enabled", "Disabled". When "Enabled" is selected, the parameter "1-byte type" appears, the options are: "scene number (1...64)", "percentage (0%...100%)", "unsigned value (0...255))"; when "scene number (1...64)" is selected, the parameter "scene number" appears, and 1~64 can be filled; when "percentage (0%...100%)" is selected, the parameter "percentage" appears, Optional 0%~100%; when "unsigned value(0...255)" is selected, the parameter "unsigned value" appears, and 0~255 can be filled.
Delay time for output(s)	can be filled from 0 to 255.
Transmission mode for output	Output transmission mode, options: "one-time transmission", "cyclic transmission". When "cyclic transmission" is selected, the parameter "cyclic time for output" appears, the options are: "1seconds", "2seconds"..."120minutes".

5.2.5 Humidity detector

humidity detector” The parameter setting interface is shown in Pic 5.2.9

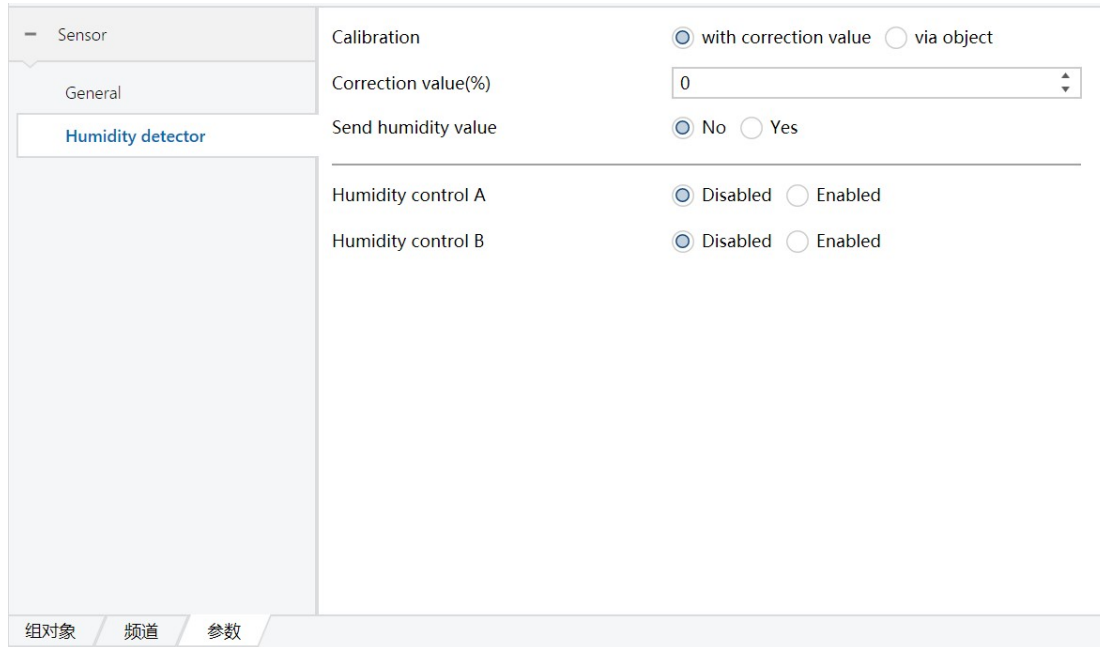

Pic 5.2.9

Parameter	Description
Calibration	This parameter is only used to calibrate the humidity value when the humidity value is obtained from the inside, the options are: with correction value, via object. After selecting with correction value, the parameter correction value appears, and the fillable range is -50~50. For example: when the actual humidity value is 60%, the detection value inside the sensor is 70%, and it needs to be filled in the VD library. Correction value -10%, or by object correction -10%.
Send humidity value	Use this parameter to determine whether to send the humidity value to the bus, options: "Yes" or "No". When selecting "Yes", the parameter "the mode for sending value" appears, and the options are: "transmit value in the event of changes", "transmit value in cycles". When "transmit value in the event of changes" is selected, the parameter "send brightness value on change" appears, the options are: change>=1%, change>=2%, change>=3%, change>=4%... .., change>=10%; when "transmit value in cycles" is selected, the parameter "the time in cycles" appears, options: 1 seconds, 2 seconds...120minutes.
Light control A	Indicates humidity control channel A, options: "Enabled", "Disabled". When "Enabled" is selected, the interface will appear as shown in Pic 5.2.10
Light control B	Indicates humidity control channel B (same as Light control A)

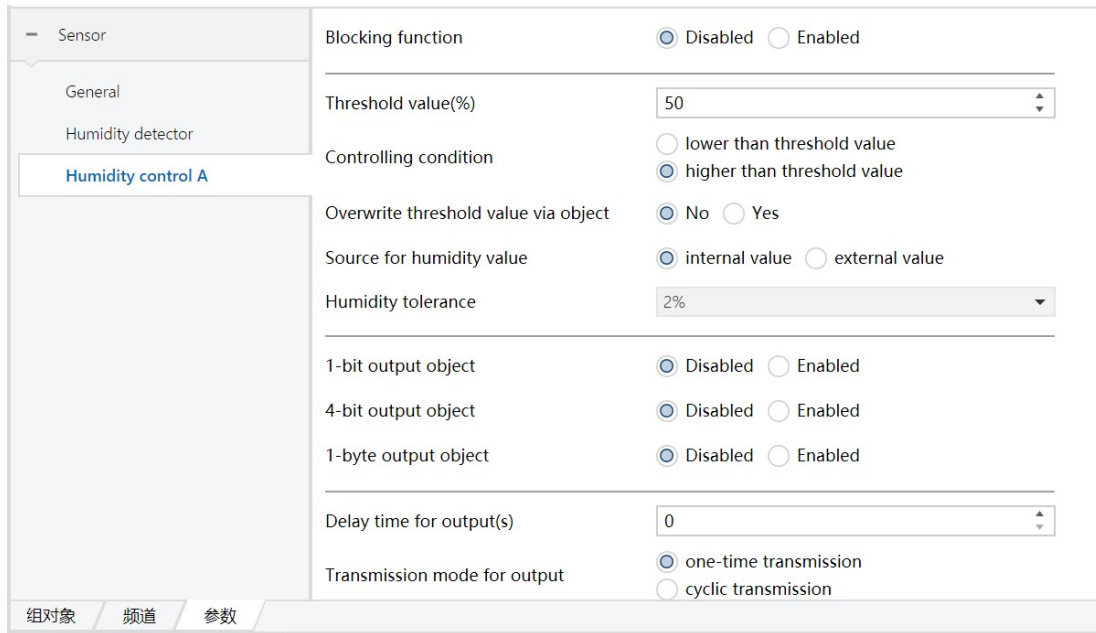

Pic 5.2.10

Blocking function	Block function, options: "Enabled", "Disabled". When "Enabled" is selected, the parameter "blocking value" will appear, options: "blocking=1, unblocking=0", "blocking=0, unblocking=1", blocking value after voltage recovery, options: "blocking", "unblocking", "as before voltage failure".
Threshold value (lux)	Indicates the threshold, optional: 0~100.
Controlling condition	Option: " lower than threshold value、 higher than threshold value"
Overwrite threshold value via object	Option: "Yes" 、 "No"
Source for humidity value	Option: "internal value" 、 "external value"
temperature tolerance	Option: 1°C、 2°C、 3°C、 4°C、 5°C、 6°C、 7°C、 8°C9°C、 10°C.
1-bit output object	Option: "Enabled" 、 "Disabled". When "Enabled" is selected, the parameter "1-bit value" appears, the options are "on", "off"
4-bit output object	This parameter is used to output 4-bit data, options: "Enabled", "Disabled". When "Enabled" is selected, the parameter "4-bit value" will appear, the options are: "Up, Break", "Up, 100%"..."Up, 1%", "down, Break", "down 100%" "...down 1%"
1-byte output object	This parameter is used to output 1byte data, options: "Enabled", "Disabled". When "Enabled" is selected, the parameter "1-byte type" appears, the options are: "scene number (1...64)", "percentage (0%...100%)", "unsigned value (0...255))"; when "scene number (1...64)" is selected, the parameter "scene number" appears, and 1~64 can be filled; when "percentage (0%...100%)" is selected, the parameter "percentage" appears, Optional 0%~100%; when "unsigned value(0...255)" is selected, the parameter "unsigned value" appears, and 0~255 can be filled.
Delay time for output(s)	can be filled from 0 to 255.
Transmission mode for output	Output transmission mode, options: "one-time transmission", "cyclic transmission". When "cyclic transmission" is selected, the parameter "cyclic time for output" appears, the options are: "1seconds", "2seconds"..."120minutes".

5.2.6 Device status feedback

This parameter is used for the status feedback of the device, the options are: "Enabled", "Disabled"; when "Enabled" is selected, the parameter "cycle time for feedback" appears, the options are: "1 seconds", "2 seconds"... "120 minutes".

6.Communication object description

The communication object is the medium through which the device communicates with other devices on the bus, that is, only the communication object can communicate on the bus. Under the function of each communication object is introduced in detail.

Note: "C" in the table attribute column below represents the communication function enable of the communication object, and "W" represents that the value of the communication object can pass through the bus

Rewrite, "R" means that the value of the communication object can be read through the bus, "T" means that the communication object has a transmission function, and "U" means that the value of the communication object can be read and updated.

6.1 Illumination function communication object

序号 ▲	名称	对象功能
0	Brightness value (calibration)	(-L...+L)
1	Brightness value (output)	value in lux
2	Light control block A	block/unblock
3	Overwrite light threshold A	value in lux
4	External brightness value A (input)	value in lux
5	Light control 1-bit output A	On/Off
6	Light control 4-bit output A	4-bit value

Pic 6.1

No.	Name	Communication object	Data type	Attribute
0	Brightness value (calibration)	(-L_+L)	2Bit	C, R, W, T
This communication object is enabled when "via object" is selected in the parameter "calibration", and the current ambient brightness value can be calibrated through this communication object.				
1	Brightness value (output)	Value in lux	2Bit	C, R, W, T
This communication object is enabled when the parameter "send brightness value" selects "yes", and this communication object can directly indicate the current ambient brightness value.				
2,8	Light control block A/B	Block/unblock	1Bit	C, R, W, T
This communication object is enabled when the parameter "Blocking function" in "light control A/B" selects "Enable". Sending a 1-bit command through this communication object can block any operation of the illumination sensor on this channel.				
3,9	Overwrite light threshold	Value in lux	2Bit	C, R, W, T
This communication object is enabled when the parameter "overwrite threshold value via object" in "light control A/B" is selected as "Yes", and a 2-byte command can be sent through this communication object to perform the illumination				

threshold of the corresponding channel to rewrite.				
4,10	External brightness value A/B (input)	Value in lux	2Bit	C, R, W, T
This communication object is enabled when the parameter "source for brightness value" in "light control A/B" selects "external value". Through this communication object, the 2-byte brightness value input by other devices can be received.				
5, 11	Light control 1-bit output A/B	On/Off	1 位	C, R, W, T
The communication object is enabled when the parameter "1-bit output object" in "light control A/B" selects "enable". Sending a 1-bit command through this communication object can control the on/off of other devices.				
6, 12	Light control 4-bit output A/B	4-bit value	4 位	C, R, W, T
This communication object is enabled when the parameter "4-bit output object" in "light control A/B" selects "enable". Sending a 4-bit command through this communication object can control the increase or decrease of dimming.				
7,13	Light control 1-byte output A/B	1-byte value	1 字节	C, R, W, T
This communication object is enabled when the parameter "1-byte output object" in "light control A/B" selects "enable". Sending a 1-byte command through this communication object can control the scene, output percentage, etc.				

Table 1.1

6.2 Mobile sensing function communication object

序号	名称	对象功能	描述
14	Motion control block	block/unblock	
15	Motion sensor trigger lock	lock/unlock	
16	Motion, Overwrite light threshold	value in lux	
17	Motion, External brightness value (input)	value in lux	
18	Motion, Master input	On/Off	
19	Start of motion, 1-bit output	On/Off	
20	Start of motion, 4-bit output	4-bit value	

序号	名称	对象功能	描述
14	Motion control block	block/unblock	
15	Motion sensor trigger lock	lock/unlock	

No.	Name	Communication object	Data type	Attribute
14	Motion control block	Block/unblock	1Bit	C, R, W, T
This communication object is enabled when the parameter "function for blocking the motion" selects "enabled", and sending "0"/"1" commands through this communication object can block or unblock any operation of the motion sensor on the channel				
15	Motion sensor trigger lock	lock/unlock	1 Bit	C, R, W, T
This communication object is enabled when "Enable" is selected in the parameter "function for locking internal trigger".				

Sending "0"/"1" commands through this communication object can block or unblock the internal trigger function of motion sensing.				
16	Motion, Overwrite light threshold	Value in lux	2 Bit	C, R, W, T
This communication object is enabled when the parameter "overwrite threshold value via object" is selected as "Yes". Sending a 2-byte command through this communication object can rewrite the illumination threshold of the corresponding channel.				
17	Motion, External brightness value (input)	Value in lux	2 Bit	C, R, W, T
This communication object is enabled when the parameter "source for brightness value" selects "external value", through which the 2-byte brightness value input by other devices can be received.				
18	Motion, Master input	On/Off	1 Bit	C, R, W, T
This communication object is enabled when the parameter "device work as" in "single or master" selects "as master device", through which the data input from the slave device can be received.				
19, 23	Start/End of motion, 1-bit output	On/Off	1 Bit	C, R, W, T
This communication object is enabled when the parameter "1-bit output object" of "start/end of motion" in "single or master" selects "enable". Sending a 1-bit command through this communication object can control other devices				
20,24	Start/End of motion, 4-bit output	4-bit value	4 Bit	C, R, W, T
This communication object is enabled when the parameter "4-bit output object" of "start/end of motion" in "single or master" selects "enable". Sending a 4-bit command through this communication object can control dimming				
21,25	Start/End of motion, 1-byte output	1-byte value	1 Bit	C, R, W, T
This communication object is enabled when the parameter "1-byte output object" of "start/end of motion" in "single or master" selects "enable". Sending a 1-byte command through this communication object can control the scene				
22	Motion, Overwrite follow-up time	In seconds	2 Bit	C, R, W, T
This communication object is enabled when "yes" is selected in the parameter "Overwrite follow-up time via object" of "follow-up time" in "single or master". Send a 2-byte command through this communication object to reset the				
26	Motion control pause	Pause/continue	1 Bit	C, R, W, T
This communication object is enabled when "enabled" is selected for the parameter "function for pausing operation" in "single or master", and the normal operation of the sensor can be paused and resumed by sending the value "0"/"1" through this communication object.				
27	Motion control abort	On/Off	1 Bit	C, R, W, T
This communication object is enabled when the parameter "function for aborting operation" in "single or master" selects "enabled", and the sensor status can be cleared by sending the value "0"/"1" through this communication object.				
28	Motion, slave output	On/Off	1 Bit	C, R, W, T
This communication object is enabled when "slave mode" is selected in the parameter "device work as", and outputs "0"/"1" to the host device through this communication object.				

6.3 Communication object of temperature function

序号	名称	对象功能	描述	群组地址	长度	C	R	W	T	U	数据类型	优先级
32	Overwrite temperature threshold A	2-byte value			2 bytes	C	R	W	T	U	temperatu...	低
34	Temperature control 1-bit output A	On/Off			1 bit	C	R	W	T	U	switch	低
30	Temperature value (output)	2-byte value			2 bytes	C	R	W	T	U	temperatu...	低
36	Temperature control 1-byte output A	1-byte value			1 byte	C	R	W	T	U	percentag...	低
35	Temperature control 4-bit output A	4-bit value			4 bit	C	R	W	T	U	blind control	低
33	External temperature value A (input)	2-byte value			2 bytes	C	R	W	T	U	temperatu...	低
31	Temperature control block A	block/unblock			1 bit	C	R	W	T	U	switch	低

30	Temperature value (output)	2-byte value	2 Bit	C, R, W, T	The communication object is enabled when "Temperature control A" selects "Enabled" in the parameter of "Temperature detector", the communication object is enabled when the parameter "send brightness value" selects "yes", this communication object can Directly indicates the current ring temperature value.
31	Temperature control block A	block/unblock	1 Bit	C, R, W, T	This communication object is enabled when "Enabled" is selected for "Blocking function" in the "Temperature control A" parameter of "Temperature detector". Sending "0"/"1" commands through this communication object can block or cancel the blocking Any operation on this channel is interrupted by temperature sensing.
32	Overwrite temperature threshold A	2-byte value	2 Bit	C, R, W, T	This communication object is enabled when "Yes" is selected for "Overwrite threshold value via object" in the "Temperature control A" parameter of "Temperature detector". Sending a 2-byte command through this communication object can The temperature threshold is rewritten.
33	External temperature value A (input)	2-byte value	2 Bit	C, R, W, T	This communication object is enabled when "eternal value" is selected in "Source for temperature value" in the parameter of "Temperature control A" in "Temperature detector". Through this communication object, 2-byte temperature value input from other devices can be received. .
34	Temperature control 1-bit output A	2-byte value	2 Bit	C, R, W, T	This communication object is enabled when "1-bit output object" selects "Enabled" in the "Temperature control A" parameter of "Temperature detector". Sending a 1-bit command through this communication object can control other devices on/ off
35	Temperature control 4-bit output A	4-bit value	4 Bit	C, R, W, T	This communication object is enabled when "4-bit output object" in the "Temperature control A" parameter of "Temperature detector" selects "Enabled". Sending a 4-bit command through this communication object can control the temperature increase or reduce.
36	Temperature control 1-byte output A	1-byte value	4 Bit	C, R, W, T	This communication object is enabled when "1-byte output object" in the "Temperature control A" parameter of "Temperature detector" selects "Enabled". Sending a 1-byte command through this communication object can control the scene, output percentage, etc.
Temperature control B 同上					

6.4 Humidity function communication object

序号	名称	对象功能	描述	群组地址	长度	C	R	W	T	U	数据类型	优先级
46	Overwrite humidity threshold A	2-byte value			2 bytes	C	R	W	T	U	humidity (%)低	
48	Humidity control 1-bit output A	On/Off			1 bit	C	R	W	T	U	switch	低
50	Humidity control 1-byte output A	1-byte value			1 byte	C	R	W	T	U	percentag...	低
49	Humidity control 4-bit output A	4-bit value			4 bit	C	R	W	T	U	blind control	低
47	External humidity value A (input)	2-byte value			2 bytes	C	R	W	T	U	humidity (%)低	
45	Humidity control block A	block/unblock			1 bit	C	R	W	T	U	switch	低
44	Humidity value (output)	2-byte value			2 bytes	C	R	W	T	U	humidity (%)低	

44	Humidity value (output)	2-byte value	2 Bit	C, R, W, T	This communication object is enabled when "Humidity control A" in the parameter of "Humidity detector" selects "Enabled", the communication object is enabled when "yes" is selected in the parameter "send brightness value", this communication object can Directly indicate the current ambient humidity value.
45	Humidity control block A	block/unblock	1 Bit	C, R, W, T	This communication object is enabled when "Enabled" is selected for "Blocking function" in the parameter of "Humidity value control A" in "Humidity value detector". Sending "0"/"1" commands through this communication object can block or Cancel any action that blocks humidity sensing for this channel.
46	Overwrite Humidity threshold A	2-byte value	2 Bit	C, R, W, T	This communication object is enabled when "Overwrite threshold value via object" is selected as "Yes" in the parameter of "Humidity value control A" in "Humidity value detector". Sending a 2-byte command through this communication object can correspond to the corresponding The humidity threshold of the channel is rewritten.
47	External Humidity value A (input)	2-byte value	2 Bit	C, R, W, T	This communication object is enabled when "eyternal value" is selected for "Source for Humidity value" in the "Humidity control A" parameter of "Humidity detector". Through this communication object, it can receive the 2-byte humidity value input by other devices.
48	Humidity control 1-bit output A	2-byte value	2 Bit	C, R, W, T	This communication object is enabled when "1-bit output object" is selected as "Enabled" in the "Humidity control A" parameter of "Humidity detector". Sending a 1-bit command through this communication object can control other devices on/ off.
49	Humidity control 4-bit output A	4-bit value	4 Bit	C, R, W, T	This communication object is enabled when "4-bit output object" in the "Humidity control A" parameter of "Humidity detector" selects "Enabled". Sending a 4-bit command through this communication object can control the increase of humidity or reduce.
50	Humidity control 1-byte output A	1-byte value	4 Bit	C, R, W, T	This communication object is enabled when "1-byte output object" in the "Humidity control A" parameter of "Humidity detector" selects "Enabled". Sending a 1-byte command through this communication object can control the scene, output percentage, etc.
Humidity control B same as above					

6.5 Device status feedback

序号	名称	对象功能	描述	群组地址
----	----	------	----	------

No.	Name	Communication object	Data type	Attribute
57	Device status	1-byte value	1 Bit	C, R, W, T
This communication object is enabled when "enabled" is selected in the parameter "device status feedback", and this communication object can directly indicate the current status of the device.				

7. Safe use and maintenance

- (1) Read all instructions carefully before use.
- (2) Keep away from air conditioners, refrigerators, stoves and other places sensitive to air temperature changes;
- (3) In the case of a certain temperature, the influence of wind speed on the sensor is not very large;
- (4) When the ambient temperature is close to the human body temperature, the sensor response is not very sensitive, and even fails;
- (5) Furniture, large bonsai, glass, curtains and other objects shall not be separated between the sensor and the detected human body;
- (6) The sensor should not face the doors and windows and places with direct sunlight (illumination and movement), otherwise the thermal air disturbance outside the window and the movement of people will cause the sensor to falsely report, and the drastic change of light will also cause the sensor to falsely report.
- (7) Humidity detection in order to correctly reflect the humidity of the space to be measured, it is also necessary to avoid placing the sensor in a dead corner that is too close to the wall or has no air circulation.
- (8) Humidity detection in order to protect the accuracy and stability of the measurement, try to avoid using it in an acidic, alkaline and organic solvent-containing atmosphere, and avoid using it in a dusty environment.
- (9) To establish a good ventilation environment.
- (10) During use, pay attention to moisture-proof, shock-proof and dust-proof.
- (11) It is strictly forbidden to be exposed to rain, contact with other liquids or corrosive gases.
- (12) If it is wet or invaded by liquid, it should be dried in time.
- (13) When the machine fails, please contact professional maintenance personnel or our company.

8. Contact

Address: 9th Floor, Building 5, Aotelang Science and Technology Park, No. 68, Nanxiang 1st Road, Huangpu District, Guangzhou City, Guangdong Province, China
 Tel: +86-20-82189121
 Fax: +86-20-82189121
 Website: <http://www.seawin-knx.com>